

GPS 152

gps trackplotter



owner's
manual
and
reference
guide

© Copyright 2001-2002 GARMIN Ltd. or its Subsidiaries

GARMIN International, Inc.

1200 East 151st Street, Olathe, KS 66062, U.S.A.

Tel. 913/397.8200 or 800/800.1020 Fax 913/397.8282

GARMIN (Europe) Ltd.

Unit 5, The Quadrangle, Abbey Park Industrial Estate, Romsey SO51 9AQ, U.K.

Tel. 44/1794.519944 Fax 44/1794.519222

GARMIN Corporation

No. 68, Jangshu 2nd Road, Shijr, Taipei County, Taiwan

Tel. 886/2.2642.9199 Fax 886/2.2642.9099

All rights reserved. Except as expressly provided herein, no part of this manual may be reproduced, copied, transmitted, disseminated, downloaded or stored in any storage medium, for any purpose without the express prior written consent of GARMIN. GARMIN hereby grants permission to download a single copy of this manual and of any revision to this manual onto a hard drive or other electronic storage medium to be viewed, and to print one copy of this manual or of any revision hereto, provided that such electronic or printed copy of this manual or revision must contain the complete text of this copyright notice and provided further that any unauthorized commercial distribution of this manual or any revision hereto is strictly prohibited.

Information in this document is subject to change without notice. GARMIN reserves the right to change or improve its products and to make changes in the content without obligation to notify any person or organization of such changes or improvements.

Visit the GARMIN web site (www.garmin.com) for current updates and supplemental information concerning the use and operation of this and other GARMIN products.

GARMIN®, Autolocate® and TracBack® are registered trademarks, and MapSource™ is a trademark of GARMIN Ltd. or its subsidiaries, and may not be used without the express permission of GARMIN.

Preface

Congratulations on choosing one of the easiest-to-use fixed-mount GPS trackplotters available! The GARMIN GPS 152 utilizes the proven performance of GARMIN GPS to create an unsurpassed marine navigation system.

To get the most out of your new GARMIN unit, take the time to read this owner's manual and learn the operating procedures for your unit. This manual is divided into two parts for your convenience.

Part One introduces you to the GPS 152 and provides a Getting Started tour to familiarize you with the unit. This section provide the basic working knowledge necessary to use the unit to its fullest potential.

Part Two is divided into sections that provide detailed references to the advanced features and operations of the GPS 152. This allows you to concentrate on a specific topic quickly and look up detailed information about the GPS 152.

If you encounter a problem or just have a question, contact our Product Support Department at 913-397-8200 or 800-800-1020, Monday – Friday, 8:00 A.M. to 5:00 P.M. Central Time.

Customer Service Product Registration

Help us better support you by completing our online registration today! Have the serial number of your GPS 152 handy and connect to our web site (www.garmin.com). Look for the Product Registration link on the Home page. Also, be sure to record your serial number in the area provided on page iv of this manual.



NOTE: We invite you to register your GARMIN product purchase using our NEW online system. Many services provided by our new product registration system are now being automated and registering your purchase ensures you the best possible support from GARMIN.

Introduction

Preface and Registration

Introduction

FCC Compliance Statement



FCC Compliance

The GPS 152 complies with Part 15 of the FCC interference limits for Class B digital devices FOR HOME OR OFFICE USE. These limits are designed to provide more reasonable protection against harmful interference in a residential installation, and are more stringent than “outdoor” requirements.

Operation of this device is subject to the following conditions: (1) This device may not cause harmful interference, and (2) this device must accept any interference received, including interference that may cause undesired operation.

This equipment generates, uses and can radiate radio frequency energy and, if not installed and used in accordance with the instructions, may cause harmful interference to radio communications. However, there is no guarantee that interference will not occur in a particular installation. If this equipment does cause harmful interference to radio or television reception, which can be determined by turning the equipment off and on, the user is encouraged to try to correct the interference by one of the following measures:

- Reorient or relocate the receiving antenna.
- Increase the separation between the equipment and the receiver.
- Connect the equipment into an outlet on a circuit different from that to which the receiver is connected.
- Consult the dealer or an experienced radio/TV technician for help.

The GPS 152 does not contain any user-serviceable parts. Repairs should only be made by an authorized GARMIN service center. Unauthorized repairs or modifications could result in permanent damage to the equipment, and void your warranty and your authority to operate this device under Part 15 regulations.

Software License Agreement

BY USING THE GPS 152, YOU AGREE TO BE BOUND BY THE TERMS AND CONDITIONS OF THE FOLLOWING SOFTWARE LICENSE AGREEMENT. PLEASE READ THIS AGREEMENT CAREFULLY.

GARMIN grants you a limited license to use the software embedded in this device (the “Software”) in binary executable form in the normal operation of the product. Title, ownership rights and intellectual property rights in and to the Software remain in GARMIN.

You acknowledge that the Software is the property of GARMIN and is protected under the United States of America copyright laws and international copyright treaties. You further acknowledge that the structure, organization and code of the Software are valuable trade secrets of GARMIN and that the Software in source code form remains a valuable trade secret of GARMIN. You agree not to decompile, disassemble, modify, reverse assemble, reverse engineer or reduce to human readable form the Software of any part thereof or create any derivative works based on the Software. You agree not to export or re-export the Software to any country in violation of the export control laws of the United States of America.

WARNING: The GPS system is operated by the United States government, which is solely responsible for its accuracy and maintenance. The system is subject to changes which could affect the accuracy and performance of all GPS equipment. Although the GARMIN GPS 152 is a precision electronic NAVigation AID (NAVAID), any NAVAIID can be misused or misinterpreted and, therefore, become unsafe.

CAUTION: Use the GPS 152 at your own risk. To reduce the risk of unsafe operation, carefully review and understand all aspects of this Owner’s Manual—and thoroughly practice operation using the simulator mode prior to actual use. When in actual use, carefully compare indications from the GPS 152 to all available navigation sources, including the information from other NAVAIIDs, visual sightings, charts, etc. For safety, always resolve any discrepancies before continuing navigation.

CAUTION: It is the user’s responsibility to use this product prudently. This product is intended to be used only as a navigational aid and must not be used for any purpose requiring precise measurement of direction, distance, location or topography.

Introduction

Software License Agreement/ Warnings and Cautions



Introduction

Warranty and Serial Number

Serial Number

Use this area to record the serial number (8-digit number located on the bottom of the unit) in case it is lost, stolen, or needs service. Be sure to keep your original sales receipt in a safe place or attach a photocopy inside the manual.

Serial Number:

* *



The GPS 152 is fastened shut with screws. Any attempt to open the case to change or modify the unit in any way will void your warranty and may result in permanent damage to the equipment.

LIMITED WARRANTY

This GARMIN product is warranted to be free from defects in materials or workmanship for one year from the date of purchase. Within this period, GARMIN will at its sole option, repair or replace any components that fail in normal use. Such repairs or replacement will be made at no charge to the customer for parts or labor, provided that the customer shall be responsible for any transportation cost. This warranty does not cover failures due to abuse, misuse, accident or unauthorized alteration or repairs.

THE WARRANTIES AND REMEDIES CONTAINED HEREIN ARE EXCLUSIVE AND IN LIEU OF ALL OTHER WARRANTIES EXPRESS OR IMPLIED OR STATUTORY, INCLUDING ANY LIABILITY ARISING UNDER ANY WARRANTY OF MERCHANTABILITY OR FITNESS FOR A PARTICULAR PURPOSE, STATUTORY OR OTHERWISE. THIS WARRANTY GIVES YOU SPECIFIC LEGAL RIGHTS, WHICH MAY VARY FROM STATE TO STATE.

IN NO EVENT SHALL GARMIN BE LIABLE FOR ANY INCIDENTAL, SPECIAL, INDIRECT OR CONSEQUENTIAL DAMAGES, WHETHER RESULTING FROM THE USE, MISUSE, OR INABILITY TO USE THIS PRODUCT OR FROM DEFECTS IN THE PRODUCT. Some states do not allow the exclusion of incidental or consequential damages, so the above limitations may not apply to you.

GARMIN retains the exclusive right to repair or replace the unit or software or offer a full refund of the purchase price at its sole discretion. SUCH REMEDY SHALL BE YOUR SOLE AND EXCLUSIVE REMEDY FOR ANY BREACH OF WARRANTY.

To obtain warranty service, call your local GARMIN authorized dealer. Or call GARMIN Customer Service at one of the numbers listed on the inside front cover of this manual for shipping instructions and an RMA tracking number. The unit should be securely packed with the tracking number clearly written on the outside of the package. The unit should be sent, freight charges prepaid, to any GARMIN warranty service station. A copy of the original sales receipt is required as the proof of purchase for warranty repairs.

Products sold through online auctions are not eligible for rebates or other special offers from GARMIN. Online auction confirmations are not accepted for warranty verification. To obtain warranty service, an original or copy of the sales receipt from the original retailer is required. GARMIN will not replace missing components from any package purchased through an online auction.

GARMIN International, Inc.
1200 East 151st Street
Olathe, Kansas 66062, U.S.A.
Phone: 913/397.8200
FAX: 913/397.0836

GARMIN (Europe) Ltd.
Unit 4, The Quadrangle, Abbey Park Industrial Estate
Romsey, SO51 9AQ, U.K.
Phone: 44/1794.519944
FAX: 44/1794.519222

Designed for detailed electronic trackplotting capability, the GARMIN GPS 152 is a powerful device that can give you the navigation information you need.

Precision Performance

- High-contrast, four-level gray, FSTN display with adjustable backlighting
- 12-channel parallel receiver tracks and uses up to 12 satellites for fast, accurate positioning
- Differential-Ready — just add an optional GARMIN beacon receiver for better than 5-meter accuracy
- WAAS Capable — receive signals from the additional set of WAAS (Wide Area Augmentation System) satellites to give you better accuracy
- Fully gasketed, high-impact plastic alloy case, waterproof to IEC 529-IPX-7 standards

Advanced Navigating and Plotting

- 500 alphanumeric waypoints with selectable icons and comments
- 20 reversible routes with up to 30 waypoints each
- Uploadable Points of Interest (POI) up to 1 Megabytes of data using GARMIN's MapSource™ PC products
- Coordinates: Lat/Lon, UTM/UPS, Loran TD, plus 24 grids, including Maidenhead
- TracBack® feature which allows you to quickly retrace your track to a starting position
- Built-in simulator mode
- Tide information from over 3000 tide stations around the U.S. coastline, Alaska, Hawaii, western Canada and several Caribbean islands

Introduction

Packing List

Before installing and getting started with your unit, please check to see that your package includes the following items. **If any parts are missing, please contact your GARMIN dealer immediately.**

Standard Package:

- GPS 152 Unit
- GA 29 External Antenna and 30-ft. cable*
- Power/Data Cable
- Mount with 2 knobs
- Owner's Manual
- Quick Reference Card

* Not included with package containing the internal antenna.

Optional Accessories:

- US A/C and PC Adapter: US version provides power and PC data connection at the same time.
- EURO A/C and PC Adapter: European version of A/C and PC Adapter
- UK A/C and PC Adapter: United Kingdom version of A/C and PC Adapter
- Cigarette Lighter Adapter
- Protective Cover
- PC Interface Cable
- MapSource Points of Interest CD-ROM
- Beacon Receiver for differential corrections: GBR21 (E-Field Antenna), or GBR23 (H-Field Antenna)
- Internal Antenna, Bail Mount (International model only)
- 2nd Mounting Station

Introduction	i-viii
Preface and Registration	i
FCC Compliance Statement	ii
Software License Agreement	iii
Warnings and Cautions	iii
Warranty and Serial Number	iv
Capabilities	v
Packing List	vi
Table of Contents	viii
“How To” Index	viii
Section One: Getting Started	1-17
Keypad Usage	1
Selecting Options	2
Entering Data	3
Initializing the Receiver	4
Power On	6
Contrast	6
Backlighting	7
Simulator Mode	7
Description of Main Pages	8
Map Page Cursor	9
Marking Waypoints	10
Going to a Destination	11
Simulated Tour	12
Reviewing and Creating Waypoints	13
Compass and Highway Pages	14
Active Route and Numbers Pages	15

Main Menu	16
Deleting Tracks	17
Power Off	17
Section Two: Reference	18-69
Map Page and Options	18
Map Page Configuration	24
Compass Page and Options	26
Highway Page and Options	27
Numbers Page and Options	29
Waypoints	30
Creating	30
Reviewing and Editing	33
Listed By Name	34
Nearest	36
Proximity	37
Going to a Destination	39
Graphically	40
TracBack	41
Man OverBoard (MOB)	43
Routes	44
Creating	44
Reviewing and Editing	46
Route List Page	46
Route Review Page and Options	47
Active Route Page	52
Main Menu Page	53
Track Tab	54

Introduction

Table of Contents

Trip Tab	56
Time Tab	56
Page Tab	56
System Tab	57
Units Tab	58
Communication Tab	60
Alarm Tab	62
Celestial Tab	63
GPS Tab	64
Tide Tab	68
Appendices	70-87
Appendix A: Loran TD	70
Appendix B: Time Offsets	72
Appendix C: Messages	73
Appendix D: Map Datums	75
Appendix E: Navigation Terms	77
Appendix F: Specifications	79
Appendix G: Installation	80
Appendix H: Advanced NMEA Setup	84
Appendix I: Index	85

Introduction

“How To” Index



The list to the right is provided to help you quickly find some of the more important procedures you will use on your new GPS 152.

TO DO THIS:	SEE PAGE(S):
Access the Main Menu	16, 53
Adjust screen contrast and/or backlighting	6-7
Change the displayed time (zone)	56
Change units of measure (statute, nautical, metric)	58-59
Configure the Map page display	21-26
Create and use a route	44-51
Enter data and select options	2-3
Go to a destination	11-15, 39-43
Initialize the GPS receiver (first time use)	4-5
Learn about the Map page	8-9, 18-26
Mark your present location as a waypoint	10, 30-31
Operate the unit's function keys	1
Pan using the map arrow	9, 18
Set Alarms	62
Set up Loran TD	71
Stop Navigation	39
Turn the unit on or off	4, 6, 17
View celestial information	63
View GPS satellite information	5, 64-67
View tide information	68-69
Zoom IN or OUT on the Map page	9, 20

MENU Key

The MENU key displays a menu of options for the current page. Press twice to display the Main Menu.

POWER/BACKLIGHT/CONTRAST Key

The POWER/BACKLIGHT/CONTRAST key turns ON/OFF the unit and display illumination.

PAGE Key

The PAGE key selects the main pages in sequence and returns display from a submenu page.

NAV/MOB Key

The NAV/MOB key displays the Go To and Follow navigation menu. It also activates the MOB (Man OverBoard) function when pressed and held for more than one second.

ARROW KEYPAD

The ARROW KEYPAD is used to select (highlight) menu options and enter data. It also controls cursor movement on the Map Page.

ENTER/MARK Key

The ENTER/MARK key selects a highlighted menu option. When entering data, it allows you to initiate entry, and then to accept the selected value(s). It also marks the current location as a waypoint when pressed and held for more than one second.

QUIT Key

The QUIT key returns the display to the previous page and, when entering data, it restores the previous value (cancels data entry).

OUT Key

The OUT key adjusts the map scale to display a larger area with less detail. (Zooms OUT)

IN Key

The IN key adjusts the map scale to display a smaller area with more detail. (Zooms IN)

Getting Started

Keypad Usage

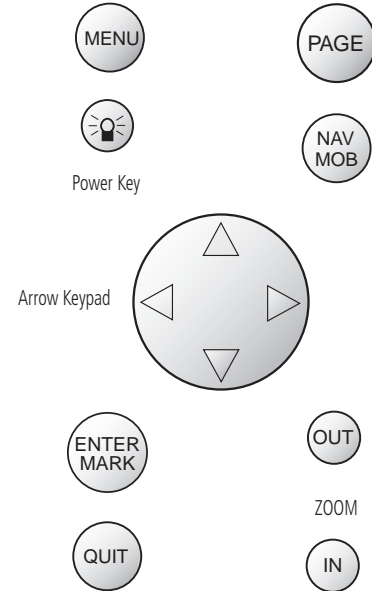

Always press and release a key to perform its primary function. Pressing and holding the **ENTER/MARK** or **NAV/MOB** keys will activate their secondary functions.

Getting Started

Selecting Options



Options Menu with a highlighted option.

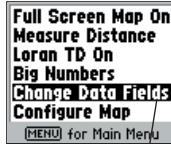

Use the ARROW KEYPAD to highlight options. Press ENTER/MARK to activate.

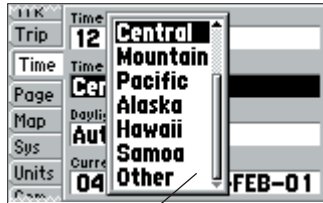

Pop-up list of options for a highlighted field.

How To Select Options and Enter Data

Before moving ahead into the features of the GPS 152, you will need to learn basic operations. We strongly encourage you to take the Getting Started tour before using your unit for actual navigation. You can select and activate options and enter data to customize the GPS 152 to fit your requirements. Use the **ENTER/MARK** key and **ARROW KEYPAD** to select options, enter names and numbers in data fields, and activate your selections.

To select and activate an optional feature:

1. With any page displayed, press the **MENU** key to pop-up the options menu. The options menu will display a list of optional features which are specific for that particular page. To select any feature on the list of options requires movement of the cursor, which is identified as highlighting, selecting or choosing an item in a list or a field (box) on a page.
2. Use the **ARROW KEYPAD** to move the cursor (highlight) up and down a list or up, down, and sideways on menus.
3. Once you have moved to the selection desired, press the **ENTER/MARK** key to either activate the feature or the **MENU** key to pop-up a sub-menu or list of yet more feature options. Just repeat this process to select an option from the list or press the **QUIT** key to return to the previous setting.

The **QUIT** key will move backwards through these steps or when pressed, back to the main page you started on.

To select and activate a function button:

1. When moving about a page with function buttons, like the 'New Waypoint' page (see page 3), you will observe functions such as 'Delete', 'Map' and 'OK'. To activate the function, highlight the desired button and press the **ENTER/MARK** key.

Naming a waypoint or placing any sort of data that has not been predefined requires the use of both the **ARROW KEYPAD** and the **ENTER/MARK** key.

To enter a name or number in a data field:

1. Once you have accessed a page with programmable data fields (i.e. 'Waypoint Edit') you can use the **ARROW KEYPAD** to move the cursor (Highlight) to fields on the page. Use the UP/DOWN arrows to move up or down and the LEFT/RIGHT arrows to move sideways.
2. Pressing the **ENTER/MARK** key with the field highlighted begins the process for entering data in the form of alphanumeric characters.
3. Use the **ARROW KEYPAD** UP/DOWN arrows to cycle through numbers 0 to 9, positive/negative symbols, blank space, and the alphabet. Pressing and releasing the keypad moves you character by character through the list. Pressing and holding the keypad moves you rapidly through the list.
4. Use the **ARROW KEYPAD** LEFT/RIGHT arrows to move to the next character on the line or backwards to edit characters. If there are more than two lines of data, keep pressing to the RIGHT to drop down to the next line.
5. When data entry is completed press **ENTER/MARK** to accept data, then move to the next programmable field. Not all data fields are programmable, like the date and time. When moving about a page with these type of fields, the cursor will skip over them.

Every field and button on this page can be programmed or activated.

A waypoint symbol can be selected from a list of symbols.

The coordinates can be changed.

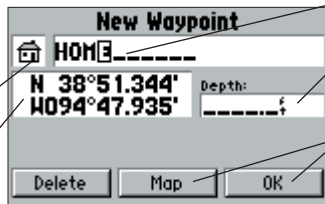

The waypoint can be renamed.

A depth can be entered.

Option buttons can be activated.

Getting Started

Entering Data

N 28°28.327'
W082°42.401'

N 28°28.328'
W082°42.401'



Pressing UP or DOWN on the ARROW KEYPAD changes the highlighted number or letter.

N 28°28.328'
W082°42.401'

N 28°28.328'
W082°42.401'

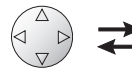

Pressing LEFT or RIGHT on the ARROW KEYPAD moves the cursor along the line or to the next line.

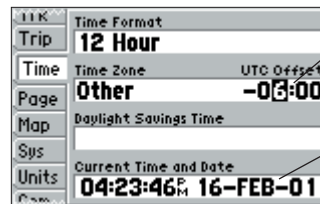

Data Entry Field

Fixed data field

Getting Started

Initializing the Receiver

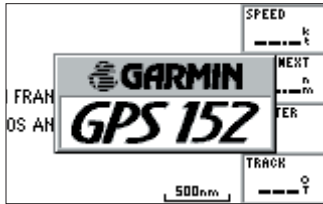

GPS 152 Self-Test Screen



GPS 152 Warning Screen

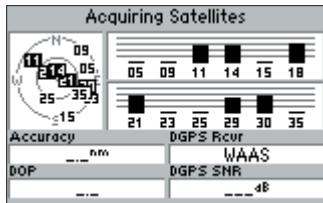

The Satellite Status screen displays until you press QUIT or ENTER or a fix is acquired.

The GPS 152's keypad system is designed to allow for fast, convenient selection of navigation options and data entry. The Getting Started Tour will introduce you to the keypad and provide a “hands-on” lesson in using the GPS 152.

The GPS 152 Quick Reference Guide contains helpful tips on using the unit and performing various navigation tasks. It's a good idea to keep the Quick Reference Guide nearby whenever you're operating your new GPS 152.

Initializing the Receiver

The first time you power up your new GPS 152, the receiver must be given an opportunity to collect satellite data and establish its present position. To ensure proper initialization, the GPS 152 is shipped from the factory in 'AutoLocate' mode, which will allow the receiver to “find itself” anywhere in the world. To speed up the initialization process, we recommend using the graphic initialization process described on the next page, which will usually provide a position fix within a few minutes.

Before you initialize, make sure the GPS 152 unit and antenna have been correctly installed on your vessel according to the instructions in Appendix G. The antenna needs to be in a location with a clear and unobstructed view of the sky to receive satellite signals.

To turn the GPS 152 on:

1. Press and hold the **POWER** key until the power tone sounds and the display comes on, then release the **POWER** key.

The Welcome page will appear while the unit conducts a self-test. Once the internal test is complete, a Warning page will appear, asking you to read and acknowledge important information regarding the proper use of the unit.

To acknowledge the warning:

1. After reading the warning, press the **ENTER/MARK** key to agree and move to the next display.

Initializing the Receiver

To graphically initialize the GPS 152:

1. Press the **MENU** key twice for the Main Menu. Press UP or DOWN on the **ARROW KEYPAD** until the 'GPS' tab is highlighted, then press the **MENU** key once.
2. Using the **ARROW KEYPAD**, highlight 'Initialize Position' and press **ENTER/MARK** to initialize the receiver from the map. The Initialize Position Page will appear, prompting you to select your approximate location with the map cursor.
3. Use the **ARROW KEYPAD** to move the map cursor and point to your approximate location within 200 miles. If you have difficulty identifying your position, press and release the **IN** key to zoom in to see the next lower map scale.
4. Once you have determined your approximate location on the map, press the **ENTER/MARK** key.



NOTE: This does not "calibrate" the unit in any way, but rather helps to speed up the initial satellite acquisition. If the unit switches to the Map Page or displays '2D' or '3D Navigation' during this process, it is not necessary to initialize the unit.

The GPS 152 will now begin searching for the appropriate satellites for your region and should acquire a fix within a few minutes. When viewing the Satellite Status page, a signal strength bar for each satellite in view will appear on the top middle of the page, with the appropriate satellite number under each bar. The progress of satellite acquisition is shown in three stages:

- No signal strength bars— the receiver is looking for the satellites indicated.
- Hollow signal strength bars— the receiver has found the indicated satellite(s) and is collecting data.
- Solid signal strength bars— the receiver has collected the necessary data and the satellite(s) are ready for use.

Once the receiver has collected information from at least three satellites, the top of the screen will display either "2D or 3D Navigation", and the GPS 152 is ready for use.



Point to your approximate location and press ENTER/MARK.

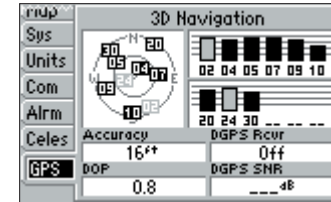

A satellite's strength bar will turn black when it's ready for use.

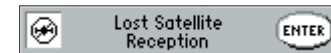

A 'Lost Satellite Reception' message appears on any screen if the navigation signal is lost.

Getting Started

Power On/ Screen Contrast

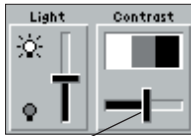

To adjust the screen contrast, press LEFT or RIGHT on the ARROW KEYPAD to move the contrast slider.

GPS 152 Getting Started Tour

The GARMIN GPS 152 is a powerful electronic navigation system that provides convenient control of many advanced features from the screen display. This tour is designed to take you through the basic pages and functions of the system using the simulator mode. Once you're familiar with the main pages and functions of the unit, use the reference section for instructions on performing specific tasks and functions.

The Getting Started tour assumes that the receiver has been properly installed and initialized, and you have not changed any of the unit's default settings. If you have changed any settings (position formats, units of measure, etc.), the descriptions and pictures in the tour may not match your configuration.

To turn the GPS 152 on:

1. Press and hold the **POWER** key until the power tone sounds, then release the **POWER** key. The Welcome Page will appear while the unit conducts a self-test.
2. Once the self-test is complete, press the **ENTER/MARK** key, if you agree, to acknowledge the warning.

The GPS Information Page will appear as the receiver begins acquiring satellites. From this page or any other page, you may also adjust the screen contrast and backlighting.

To adjust the screen contrast:

1. Press **POWER** and the Light and Contrast adjustment window will appear.
2. To decrease or increase the screen contrast, press LEFT or RIGHT on the **ARROW KEYPAD**.
3. Press the **ENTER/MARK** key to finish.

The GPS 152's adjustable screen backlighting is controlled with the **POWER** key, and may be adjusted at any time from any page. The backlight can cycle through off, user-defined, and maximum backlight levels by repeatedly pressing the **POWER** key.

To turn on and adjust the backlighting:

1. Press **POWER** and the Light and Contrast window will appear.
2. Press **POWER** again and the user-defined level of backlighting will activate. You may adjust this level by pressing UP or DOWN on the **ARROW KEYPAD**. If you press **POWER** one more time, the backlighting will be at the maximum setting.
3. Press **ENTER/MARK** or **QUIT** when done.

The backlight will now cycle through off, the user-defined, and maximum backlight levels by repeatedly pressing the **POWER** key.

Each page and the Main Menu of the GPS 152's system may also feature menu options, which give you access to other functions and features that relate to the screen you are viewing. To get a feel for how the option menus work, put the GPS 152 into simulator mode.

To place the GPS 152 in simulator mode:

1. From any page, press the **MENU** key twice. The Main Menu will appear, displaying a tab style list of options and functions.
2. Use the **ARROW KEYPAD** to highlight the 'Sys' (System) tab, then press RIGHT then DOWN until the field below the word 'System Mode' is highlighted and press **ENTER/MARK**.
3. Highlight 'Simulator' and press **ENTER/MARK**. Press **ENTER/MARK** again to confirm the 'Running Simulator' message that appears at the bottom of the display.

Once the simulator has been started, the lower left corner will display an 'S' in a box on the main pages to show "Simulating Navigation" status. Now you're ready to continue the rest of the simulated tour. **Keep in mind that the GPS 152 does not track satellites in simulator mode, and this mode should never be used for actual navigation.** All the waypoint and route planning done in simulator mode will still be retained in memory for future use.

Backlighting/ Simulator Mode

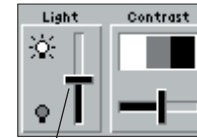

Press UP or DOWN on the **ARROW KEYPAD** to move the backlighting slider up for brighter or down for dimmer backlighting.



When the unit is in Simulator mode, an 'S' will appear in the lower left corner of the main pages to indicate the unit is simulating navigation.

Getting Started

Main Pages/ Map Page

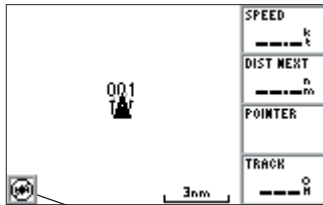

Before satellite acquisition, or if satellite reception is lost, this icon in the lower left corner indicates that there is no GPS fix.

The GPS 152's system displays five main pages: the Map Page, Compass Page, Highway Page, Active Route Page and Numbers Page. All five pages are linked together in a simple chain, which allows you to scroll through the pages in either direction using the **PAGE** and **QUIT** keys.

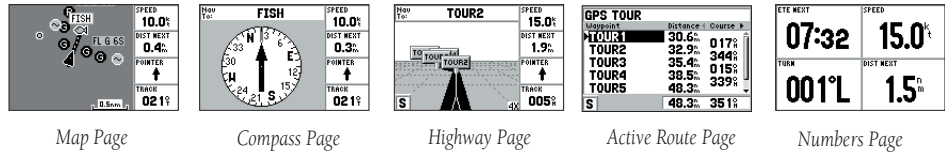

To continue the tour, move to the Map Page.

To scroll to the next page in sequence:

1. Press the **PAGE** key.

The GPS 152's Map Page combines trackplotting with a user-selectable display of navigation data. It will also be the page you use most to create and edit waypoints and routes. Before you take off on a practice route, take a brief look at its various features and displays.

The map display shows your "boat" as a triangle marker. City names (Larger than 200,000 population), marine markers and buoys (for the Americas only, preloaded from the factory) are also shown. Additionally, it displays your track, routes and nearby waypoints. An on-screen cursor lets you pan to other map areas, determine the range and bearing to a position, and perform various waypoint and route functions.

The data window, located on the right side of the page, provides a user-selectable display of various navigation data, including course, speed over ground, and bearing and distance to a particular waypoint. The current map scale setting is located at the bottom right of the map window.

The Map Page Cursor

Working from the Map Page is a simple process that centers around the use of the cursor. Controlled by the **ARROW KEYPAD**, the cursor is an important tool that can be used to pan to other map locations, mark and edit waypoints and routes, and review position data of on-screen map items and waypoints.

To get a feel for using the Map Page and using the cursor, try the following exercise:

1. Use the **IN/OUT** keys to set the map scale to the 50 nm setting. Your boat should be near the center of the map, at the receiver's last known position (If your boat isn't where it should be, make sure that you have initialized the receiver and acquired a position as described on pages 4-5).
2. Use the **ARROW KEYPAD** to move the cursor. Notice how another data field, 'Map Pointer', appears at the top of the page. This field shows the bearing and distance from your boat to the cursor, along with the latitude/longitude of the cursor.
3. Press the **QUIT** key to remove the cursor and re-center your boat on the map display.

As you become more familiar with the cursor, you'll see that the map display actively scrolls or "pans," letting you explore areas around the world and create waypoints and routes. Wherever you move the cursor, you'll always be just one **QUIT** key press away from returning the map to your present position.

Now that you've seen how the GPS tab and Map Page can be used to monitor satellite acquisition and your present location, let's take a minute to learn how to mark and store your present position as a waypoint (Since you're in simulator mode, the present position displayed will be the last position calculated by the receiver, which should be the spot where you've initialized the unit). This will also give you an opportunity to see how the GPS 152's keypad and **ENTER/MARK** key are used for data entry and changing the waypoint name and symbol.

Map Cursor

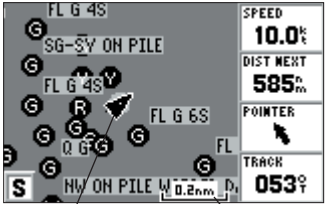

Current position Map Scale

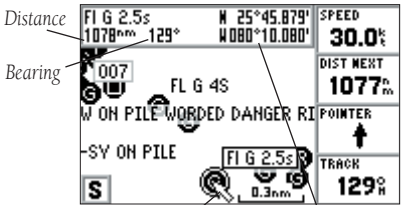

Map Cursor Cursor Coordinates

Getting Started

Marking Waypoints

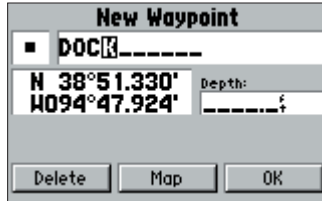

Press ENTER/MARK after entering the name.

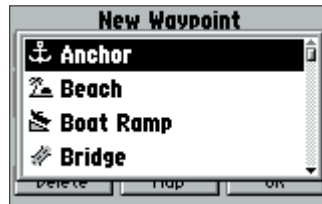

Choose from a list of 40 useful symbols to represent your waypoint on the Map Page.

Marking Waypoints

To mark your present position:

1. Hold down the **ENTER/MARK** key until the 'New Waypoint' window appears, then release the key. The window will show a default 3-digit waypoint name/number (001), symbol (dot), and position. You can leave the name as the auto-assigned number, but for this exercise, change the name to 'DOCK'.
2. Use the **ARROW KEYPAD** to highlight the waypoint name field (001) and press **ENTER/MARK**. You will see that just the first '0' is now highlighted.
3. Press LEFT on the **ARROW KEYPAD** to clear the name field.
4. Press the UP or DOWN arrow of the **ARROW KEYPAD** until the letter 'D' appears, and then press the RIGHT arrow key to go to the next space to the right, then UP or DOWN again until 'O' appears. Repeat this until you have entered the name 'DOCK'. If you make a mistake and select an incorrect character, simply use the LEFT arrow key of the **ARROW KEYPAD** to backspace the cursor and then UP or DOWN to correct the entry. (If you accidentally press **ENTER/MARK** before you are done, simply press **ENTER/MARK** again and move the highlight to where you left off.)
5. After you have entered all the letters, press **ENTER/MARK** to confirm the name.
6. To access the waypoint symbol page, highlight the waypoint symbol field which is to the left of the waypoint's name and press **ENTER/MARK**. Note that the default symbol is a dot.
7. You will see an alphabetical list of available waypoint symbols to choose from. You will see a scroll bar on the right of the window indicating your current position on the entire list of symbols. Press the **ARROW KEYPAD** UP or DOWN until you highlight the 'ANCHOR' symbol.
8. Press **ENTER/MARK** to confirm the 'ANCHOR' symbol.
9. Highlight 'OK' at the bottom of the window and press **ENTER/MARK** again to confirm the 'OK' prompt and save the waypoint. You may also highlight 'Delete' and press **ENTER/MARK** to not save the waypoint.

The waypoint is now stored in memory. Note that waypoints may also be created graphically with the Map Page cursor or by manually entering position coordinates. These techniques are described in the reference section of the manual and/or on the GPS 152 Quick Reference Guide.

Going to a Destination

GPS is all about marking positions as waypoints and navigating to them using the receiver's steering guidance and map displays. You've already seen how to use the **ENTER/MARK** key to store our present position, so it's time to move on to the fun part—going to a destination.

The **NAV/MOB** key, located on the left side of the keypad below the **PAGE** key, is the primary tool used to select a destination waypoint, a route to navigate, or start a TracBack. The **NAV/MOB** key can be used in three primary ways:

- Pressing **NAV/MOB** once displays a list of options from which you can select 'Go To Waypoint', 'Follow Route', 'Follow Track', or 'Stop Navigation'.
- Holding down **NAV/MOB**, or pressing the key two times, activates the MOB (Man OverBoard) feature. This marks the point at which the MOB was activated as a waypoint named "MOB" and also establishes it as an active "Go To" point.
- Highlighting an on-screen waypoint, map feature or map location as a destination directly from the Map Page and pressing **NAV/MOB** allows you to graphically select points to "Go To".

For the simulated trip, you're going to select a pre-programmed tour route using the first method. This will also show how the **MENU** key is used throughout the GPS 152 system to provide tab style options and functions. Start by changing the position to where the practice route is located.

To change the GPS 152 position in simulator mode:

1. Press the **MENU** key twice to display the list of Main Menu tab items.
2. Use the UP or DOWN arrow of the **ARROW KEYPAD** to highlight the 'Sys' tab.
3. Highlight 'Set Options' in the lower right and press **ENTER/MARK**, then highlight 'Set Position' in the simulator setup window and press **ENTER/MARK**.
4. From the Initialize Position page, press the **MENU** key. With 'Enter As Text' highlighted, press **ENTER/MARK**.
5. On the Enter Position window, press **ENTER/MARK** then use the **ARROW KEYPAD** to enter N34°56.800', W076°24.066' and press **ENTER/MARK** when done.

Getting Started

Using the NAV/MOB Key



System tab simulator setup options.



Text entry for simulator position.

Getting Started

Simulated Tour

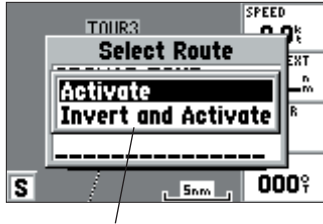

You may also Invert a route to follow it in reverse.



Simulator setup window.

Simulated Tour

To activate the practice route stored in memory for navigation:

1. Press **NAV/MOB**. The option list page will appear. (If you were selecting a single waypoint to navigate to rather than a route, we could highlight the waypoint on the map, press **NAV/MOB** and then press **ENTER/MARK**.)
2. Use the **ARROW KEYPAD** to highlight the 'Follow Route' option. Press **ENTER/MARK** to confirm.
3. The Select Route page will appear, with the 'GPS TOUR' route highlighted.
4. Press **ENTER/MARK** then highlight 'Activate' and press **ENTER/MARK** again.

To get a better view, zoom in to a closer map scale.

1. Repeatedly press the **IN** key until you select the 5 nm scale. (Note: you may also hold the **IN** or **OUT** keys down to quickly scroll through the map scales.)

The Map Page should now display the first three waypoints chained together in a simple route, with your boat at the first route waypoint. A data field at the right of the page will now display the speed, distance to the next route waypoint, and a pointer which shows you which way to go. To get started, let's enter a speed for our vessel, which we can do from the Main Menu Page.

To enter a boat speed:

1. Press the **MENU** key twice to display the Main Menu Page.
2. Use the **ARROW KEYPAD** to highlight the 'Sys' tab, then highlight the 'Set Options' button and press **ENTER/MARK**.
3. Highlight the field below 'Speed' and press **ENTER/MARK**. Use the **ARROW KEYPAD** to enter a speed of 60 knots.
4. Press **ENTER/MARK** to finish, and **QUIT** until you return to the Map Page.

Once a speed has been entered, you'll notice that the map will automatically begin to move slowly, keeping your boat centered on the display. The direction of movement, also called 'track', will be controlled by the simulator.

Getting Started

You'll now have a clearer picture of the route you are navigating. Press the **IN** key to zoom in to the 2 nm scale. Now that you've zoomed in a little closer to your route, you can pan ahead of your vessel with the cursor to review map items and create on-screen waypoints. Try moving the cursor to highlight the 'TOUR3' waypoint—just use the **ARROW KEYPAD** to move the cursor as close as possible to the waypoint. (To move the cursor in small increments, try a series of short key presses.)

Once the cursor is over the TOUR3 waypoint, you'll notice that the waypoint symbol and name will become highlighted. The data field at the top of the page will display the waypoint name, the range and bearing from your present position, and the coordinates for the waypoint.

To review a selected waypoint:

1. With the desired waypoint highlighted on the Map Page, press the **ENTER/MARK** key. The Waypoint Review page appears.
2. To return to the Map Page, highlight 'OK' and press **ENTER/MARK**, or just press **QUIT**.

The cursor can also be used to create new waypoints right from the map display.

To create a new waypoint using the cursor:

1. Use the **ARROW KEYPAD** to move the cursor as close as possible to the following position: N35° 02.187'; W 076° 26.167' (Use the data window to verify the cursor position.)
2. Press and quickly release the **ENTER/MARK** key to capture the cursor position (pressing and holding the **ENTER/MARK** key will mark your current position, not the cursor position). The 'New Map Waypoint' page will appear.
3. Use the **ARROW KEYPAD** to highlight the waypoint symbol field to the left of the waypoint name/number.
4. Press **ENTER/MARK** to access the symbol page.
5. Press UP or DOWN on the **ARROW KEYPAD** to select the 'Shipwreck' symbol and press **ENTER/MARK** to confirm.
6. Highlight the 'OK' button and press **ENTER/MARK** again to finish.

Reviewing/Creating Map Waypoints

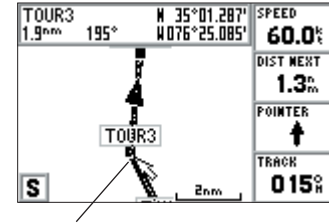

Highlighting a waypoint with the Map Page cursor.

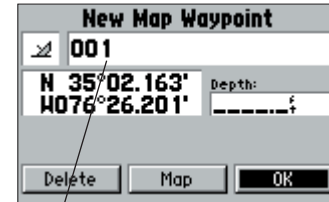

Waypoint numbering will start with 001 and continually count up, even if the waypoint name has been deleted.

Getting Started

Compass/Highway Pages

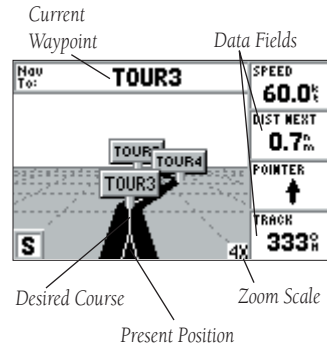
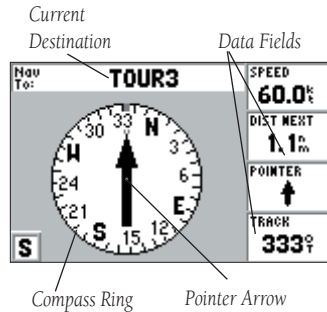

Now that we're navigating to an actual destination, let's move on to the GPS 152 navigation pages by pressing the **PAGE** key. The GPS 152 features two different navigation pages: Compass and Highway. The Compass Page is first. This page provides graphic steering guidance to a destination waypoint, with an emphasis on the bearing to your destination and current direction of travel, while the Highway Page places greater emphasis on the straight-line desired course and the distance and direction you are off course.

The middle of the Compass Page features a rotating 'compass ring' that shows your course over ground (track) while you're moving, and a bearing pointer that indicates the direction of the destination (bearing) relative to the course over ground. The compass ring and pointer arrow work independently to show, at a glance, the direction of your movement and the direction to your destination. For instance, if the arrow points up, you are going directly to the waypoint. If the arrow points any direction other than up, turn toward the arrow until it points up, then continue in that direction.

The current speed and distance to the next waypoint as well as the pointer to the next waypoint are displayed on the right side of the screen. This page provides better steering guidance than the Highway Page when travelling at slower speeds and/or when making frequent directional changes. When you are not navigating to a waypoint, the compass will show your direction of travel as you move but the arrow will not appear.

Let's move on to the Highway Page by pressing the **PAGE** key. The GPS 152's Highway Page also provides graphic steering guidance to a destination waypoint. As you head toward your destination, the middle of the screen provides visual guidance to your waypoint on a moving graphic "highway." Your present position is at the bottom center of the highway display. The line down the middle of the highway represents your desired course. As you navigate toward a waypoint, the highway will actually move, indicating the direction you're off course.

Getting Started

To stay on course, simply steer toward the center of the highway or “keep it on the road”. The four default data fields on the right side of the page indicate speed and distance to the next destination (or the next waypoint in a route), along with a pointer arrow which points the next waypoint and the compass track you are heading. Use the Highway Page as your primary navigation page (in lieu of the Compass Page) when your main concern is following a defined course.

If you get off course, the highway will move to give you graphic guidance to get back on course. You can use the **IN** or **OUT** keys to zoom in or out on the Highway display for a smaller or larger view. Five available settings range from 1X to 16X, with a default setting of 8X. The current scale will appear in the bottom right of the display.

While in simulator mode, you may also adjust the speed and course on the Highway Page.

To adjust the speed and course while in simulator mode:

1. Press **LEFT** or **RIGHT** on the **ARROW KEYPAD** to adjust the course and press **UP** or **DOWN** to increase/decrease the speed in 10 kph/mph increments.

Press **PAGE** to see the next page appearing in the main sequence, which is the Active Route Page. Whenever you have activated a route or TracBack, this page will show each waypoint name along with useful data for each point. As you navigate the route, the information will automatically update to indicate the next point along the route, which is denoted by an arrow on the left-hand side of the screen. For more detailed information on the Active Route Page, see page 52.

Press **PAGE** to see the last page appearing in the main sequence, the Numbers Page. The default page will display four user-selectable data fields showing the speed, pointer, distance to the next waypoint, and current track. You may also choose to show one data field in large lettering for better readability using the ‘Big Numbers’ option.

To toggle between full screen data and four data display:

1. Press **MENU**, then highlight either ‘Big Numbers’ or ‘Small Numbers’ and press the **ENTER/MARK** key.

Highway/Active Route/ Numbers Pages

Waypoint	Distance	Course
TOUR1	30.6 ^m	017 ^o H
TOUR2	32.9 ^m	344 ^o H
TOUR3	35.4 ^m	015 ^o H
TOUR4	38.5 ^m	339 ^o H
TOUR5	48.3 ^m	
S	48.3 ^m	351 ^o H

Active Route Page

SPEED 60.0 ^{k_t}	POINTER ↑
DIST NEXT 1.9 ^{n_m}	TRACK 007 ^o T

Numbers Page

SPEED 60.0 ^{k_t}

Numbers Page with Full Screen Data

Getting Started

Data Fields/ Main Menu Page



You may choose from 28 different types of data.



Main Menu page with the 'Wpt' tab selected.

Data fields on the main pages (except the Active Route Page) may also be configured to display any of 28 different information categories (see pages 22-23 for the complete list). On the Numbers Page, change the 'POINTER' field to 'POSITION'.

To change a data field:

1. Press the **MENU** key to display the Numbers Page options.
2. Use the **ARROW KEYPAD** to highlight 'Change Data Fields' and press **ENTER/MARK**.
3. Once the menu window disappears, use the **ARROW KEYPAD** and highlight 'POINTER', then press **ENTER/MARK**.
4. On the alphabetical list of options, press the **ARROW KEYPAD UP** or **DOWN** until you highlight 'POSITION' and press **ENTER/MARK** (you may also press **LEFT** or **RIGHT** on the **ARROW KEYPAD** to scroll the list a page at a time). You will see a scroll bar on the right side of the window indicating your current position on the entire list of options.
5. Press **QUIT** when done.

As you've seen, the primary pages provide map and navigation information. The tour's last page is the Main Menu page, which allows access to the GPS 152's waypoint, route and planning functions, various operational and navigation setup features, and celestial and tidal data.

The Main Menu is available from any page, and is accessed through the **MENU** key.

To access the Main Menu page:

1. Press the **MENU** key twice.

The Main Menu page lists 14 menu 'tabs' that are divided into categories by function. You can view a particular menu by simply highlighting the desired tab, which will then show any secondary submenu tabs and options for that tab.

To get a feel for how the Main Menu page works, clear out the track log you created during the simulated tour. This will ensure that you have a clean slate once you start navigating in your home waters.

To select the Track submenu tab:

1. Use the **ARROW KEYPAD** to highlight the 'Trk' tab on the Main Menu page. You will see the options for the Track tab appear to the right of the Main Menu list.
2. Press **RIGHT** on the **ARROW KEYPAD** to highlight the 'Active' tab.

The Track Log Page allows you to specify whether to record a track plot, define how it is recorded and save your current track log. It also provides both an indicator of the percentage of total memory used and menu options to save or clear the active track log.

To clear the active track log:

1. With the 'Active' Track submenu selected, press **MENU** then highlight the 'Clear' option and press **ENTER/MARK**. A confirmation page will appear.
2. Highlight the 'OK' prompt and press **ENTER/MARK** to confirm.
3. Press **PAGE** or **QUIT** to return to any of the main pages.

Congratulations! You've now gone through the basic operation of the GARMIN GPS 152. Your new GPS is a powerful tool with many advanced features not covered in the Getting Started tour. For detailed instructions on using these features or performing a specific task, please refer to the Quick Reference Guide or the appropriate reference section of this manual.

To turn the GPS 152 off:

1. Press and hold the **POWER** key for about 2 seconds, until the screen is blank.
2. When the screen is blank, release the **POWER** key.

The next section of the manual describes the pages and functions of the GPS 152 in detail. If you are unable to locate a specific option or function, please refer to the Index on pages 85-87. Thank you for choosing the GARMIN GPS 152 navigation unit. We hope it will be a useful and fun tool for you wherever you go!

Deleting Track Logs/ Powering Off Unit

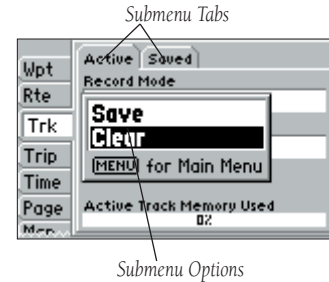

Reference

Map Page

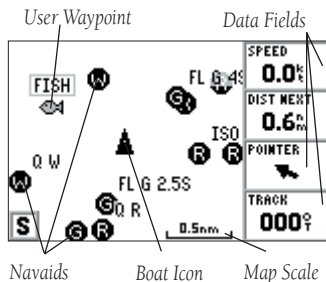

If MapSource Points of Interest or other MapSource data is loaded into the unit, the tides, cities and marine nav aids will be deleted from the system. Check the GARMIN web site (www.garmin.com) for updates to reinstall the original factory-loaded data.

Map Page

The GPS 152's Map Page provides a display of plotting and navigational data. The unit is preloaded from the factory with a worldwide database of cities greater than 200,000 in population and marine nav aids, for the Americas only. It also plots your track and displays any routes and waypoints you create. An on-screen cursor lets you pan and scroll to other map areas, determine the distance and bearing to a position, and perform various route and waypoint functions.

Two basic map operating modes, position mode and cursor mode, determine what is shown on the map display. Position mode pans the map to keep the present position marker (triangle) within the display area, while cursor mode pans the map to keep the cursor (arrow pointer) within the display area. The GPS 152 will always power up in the position mode, with your vessel centered on the map display. Whenever the **ARROW KEYPAD** is pressed, the GPS 152 will enter cursor mode.

When the cursor is active, an additional data window will appear at the top of the screen to indicate the position, range and bearing to the cursor or a selected waypoint or map item.

Using the Cursor

The cursor allows you to pan away from your present position and scroll to other map areas around the world. As you pan past the edge of the current map display, the screen will actively scroll forward to provide continuous map coverage (keep in mind that the boat icon will move with the scrolling map, and may not be visible on the display screen).



NOTE: When the cursor reaches the edge of the map, the unit may pause as it loads new data.

To move the cursor:

1. Press the **ARROW KEYPAD** to move the cursor in an up, down, left or right direction.

As you move the cursor, the distance and bearing from your present position to the cursor will be displayed in the data window, along with the cursor's position coordinates. When you zoom in cursor mode, the cursor will be centered on the screen. When the cursor is stationary, a fixed coordinate position will appear in the position field, and the distance and bearing from your present position will change as your boat moves.

To eliminate the cursor and re-center your position on-screen:

1. Press the **QUIT** key.

The cursor may also be used to snap-to on-screen waypoints and map items, allowing you to review details about a selected position directly from the map display.

To select an on-screen waypoint or map item with the cursor:

1. Use the **ARROW KEYPAD** to move the cursor to the desired waypoint or map item. If there are several waypoints grouped closely together, zoom **IN** closer for a better view.
2. When a waypoint or map item is selected, it will become highlighted on screen, with the name and position displayed at the top of the screen.

To view additional details about an on-screen waypoint or map item:

1. With the desired waypoint or map item highlighted, press **ENTER/MARK**.
2. If the item is a waypoint, the Waypoint Review window will appear, showing the waypoint name, symbol, coordinates and depth (all of which are editable), and the options to 'Delete' the waypoint, show it on the 'Map', or 'OK' to return to the Map Page. Use the **ARROW KEYPAD** to highlight 'OK' or press **QUIT** to exit the Waypoint Review page.

If the item is a map feature, such as a city, an Information page will appear, showing the name, distance and bearing from your current position, and the options to show it on the 'Map' or 'Create Waypt'. Press **QUIT** to exit the Information page.

Map Page Cursor

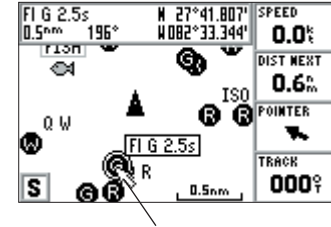

Move the cursor over an item on the map to highlight it.

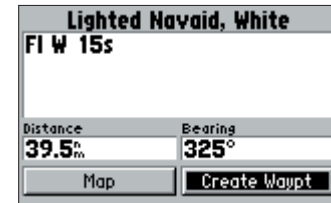

Pressing ENTER/MARK while highlighting a map item will bring up the Information page for that map feature.

Reference

Creating Waypoints with the Map Page Cursor

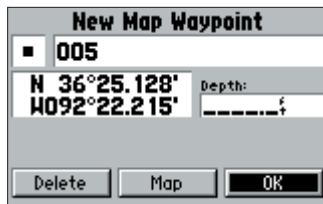

Creating a New Map Waypoint

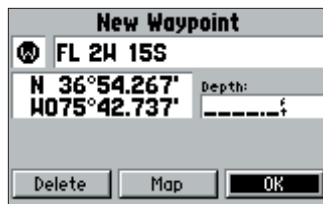

Creating a New Waypoint from a Map Feature

The cursor may also be used to create new waypoints directly from the map.

To create a waypoint with the cursor on an open map location:

1. Use the **ARROW KEYPAD** to move the cursor to the desired map position.
2. Press and quickly release the **ENTER/MARK** key to capture the cursor location (pressing and holding the **ENTER/MARK** key will capture the current location, not the cursor's location).
3. The 'New Map Waypoint' window will appear. With 'OK' highlighted, press **ENTER/MARK** to confirm the new waypoint using the default three-digit name and symbol.

To create a waypoint with the cursor on a map item:

1. Use the **ARROW KEYPAD** to move the cursor and highlight the desired map feature.
2. Press the **ENTER/MARK** key to capture the cursor location. The Information page for that feature will appear. Use the **ARROW KEYPAD** to highlight 'Create Waypt' and press **ENTER/MARK**.
3. The 'New Waypoint' window will appear. With 'OK' highlighted, press **ENTER/MARK** to confirm the new waypoint using the default name and symbol based on the map feature.

Selecting Map Scales

The map display has a range of 24 available scales from 120 ft. to 800 mi. (30 mt. to 1200 km). The map scale is controlled by the **IN** and **OUT** keys, with the current scale displayed at the bottom right of the data window.

To select a map scale:

1. Press the **OUT** key to zoom out and the **IN** key to zoom in.



The scale value represents the distance from one end of the scale bar to the other.

Map Page Options

Many features of the GPS 152 are menu driven. Each of the main pages has an options menu, allowing you to customize the corresponding page to your preferences and/or select special features that specifically relate to that page. The data window (located at the right of the Map, Compass and Highway pages, and the entire screen on the Numbers page) provides a user-selectable layout of various types of useful data. Each data field may be configured to display any one of 28 data options. The data window layout may also be changed to display additional data fields and change the actual size of the data displayed. The GPS 152's Map Page options menu provides access to functions and features relating to the Map Page and options for layout of the page.

To display the Map Page options:

1. Press **MENU**.

To select a menu option:

1. Use the **ARROW KEYPAD** to highlight the desired option and press **ENTER/MARK**.

The Map Page options include: Full Screen Map On/Full Screen Map Off, Measure Distance, Loran TD On/Loran TD Off, Small Numbers/Big Numbers, Change Data Fields, and Configure Map. Following are details on using each of these options.

• **Full Screen Map On/Full Screen Map Off** — toggles between a Map Page without or with data fields on the map display.

To maximize the map/show data fields:

1. Highlight the 'Full Screen Map On' option and press **ENTER/MARK**. The Map Page will now be maximized with no data fields.
2. To show the data fields again, press **MENU**, highlight 'Full Screen Map Off' and press **ENTER/MARK**.

Map Page Options



Map Page Options

Reference

Map Page Options

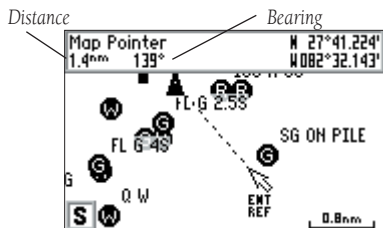

Measuring Distance/Bearing
(Full Screen Mode shown)

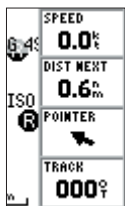

Small Numbers
(4 fields)

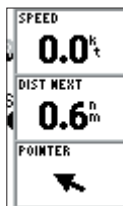

Big Numbers
(3 fields)

• **Measure Distance** — allows you to measure the bearing and distance between any two points on the map display.

To measure the Bearing/Distance between two points:

1. Highlight the 'Measure Distance' option and press **ENTER/MARK**. An on-screen pointer will appear on the map display at your present position with 'ENT REF' below it.
2. Move the cursor to the desired reference point (the point that you want to measure from) and press **ENTER/MARK**.
3. Move the cursor to the point that you want to measure to. The bearing and distance from the reference point will be displayed in the data window at the top of the display.
4. Press the **QUIT** key to finish.

• **Loran TD On/Off** — allows you to toggle the position coordinate format between the current grid and Loran TD (Time Delays). For setup of Loran TD, see pages 70-71.

• **Big/Small Numbers** — allows you to change the text size and number of data fields that will be displayed. Big Numbers will display three data fields with larger text and Small Numbers will display four data fields with smaller text.

To toggle between Big Numbers and Small Numbers:

1. Highlight the 'Big Numbers' or 'Small Numbers' option and press **ENTER/MARK**.

• **Change Data Fields** — allows you to specify the type of data displayed in each data field used on the map display.

The following options are available for display in data fields on the Map, Highway, Compass, and Numbers pages:

- BEARING – Compass direction from your position to destination
- COURSE – Course over ground
- DEPTH – Depth below transducer (if receiving proper sonar NMEA data from other device)
- DIST TO DEST – Distance to final waypoint (destination)

- DIST TO NEXT – Distance to next waypoint
- ELEVATION – Elevation (altitude) above/below MSL (Mean Sea Level)
- ETA AT DEST – Estimated Time of Arrival to final waypoint
- ETA AT NEXT – Estimated Time of Arrival to next waypoint
- GPS ACCURACY – Estimated accuracy of the GPS position
- MAX SPEED – Fastest speed the unit has traveled
- MOV AVG SPEED – Average moving speed
- MOV TRIP TIMER – Time unit has been moving for a trip
- OFF COURSE – Distance and direction from desired track
- POINTER – Arrow points to your destination
- POSITION – Current position (only available when using Big Numbers option)
- SPEED – Speed over ground/water
- TIME OF DAY – Current time
- TIME TO DEST – Time to final waypoint (destination) at current speed and course
- TIME TO NEXT – Time to next waypoint at current speed and course
- TO COURSE – Direction to desired track
- TRACK – Current compass heading
- TRIP ODOM – Trip Odometer
- TTL AVG SPEED – Total average speed
- TTL TRIP TIMER – Total travel time of trip, stopped and moving
- TURN – Turn angle to waypoint
- VMG – Velocity Made Good to destination
- WATER SPEED – Speed through the water (if receiving proper sonar NMEA data from other device)
- WATER TEMP – Water temperature (if receiving proper sonar NMEA data from other device)

To change a data field:

1. Highlight the 'Change Data Fields' option and press **ENTER/MARK**.
2. Move the field highlight to the data field you want to change and press **ENTER/MARK**.
3. Move the **ARROW KEYPAD** UP or DOWN to highlight the data you want to display, and press **ENTER/MARK**. To change another data field, repeat steps 2 and 3. To exit, press **QUIT**.

Reference

Map Page Options

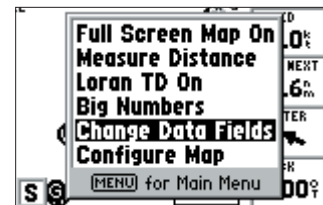

Change Data Fields Option



Scroll bar shows your position on the alphabetical list.

Reference

Map Page Options

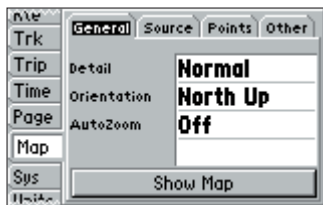

General Tab

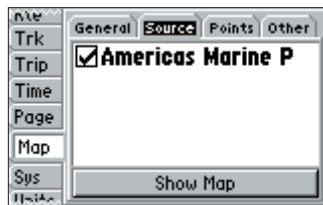

Source Tab

• **Configure Map** — jumps to the Map tab of the Main Menu, allowing you to configure the map display to your preferences, including map detail, map orientation, automatic zoom, and various map items and points. The map configuration option uses a 'file tab' feature, making it easier to organize the various settings for ease of use.

To change a map setup feature:

1. From the Map Page menu, highlight the 'Configure Map' option and press **ENTER/MARK**.
2. Move LEFT or RIGHT on the **ARROW KEYPAD** to highlight the desired file tab, then UP or DOWN on the **ARROW KEYPAD** to highlight the setting you want to change and press **ENTER/MARK**.
3. Move UP or DOWN on the **ARROW KEYPAD** to highlight the desired setting and press **ENTER/MARK**.
4. To exit, press **QUIT**.

While configuring the map setup, or after making a change, you may want to view the map to see how it looks or how it has changed.

To view the map during Map page configuration:

1. On any of the map setup file tabs, use the **ARROW KEYPAD** to highlight the 'Show Map' button and press **ENTER/MARK**. The map setup information within the file tab will be replaced with a small version of the map.
2. To return to the Map page setup, highlight the 'Show Map Setup' button and press **ENTER/MARK**.

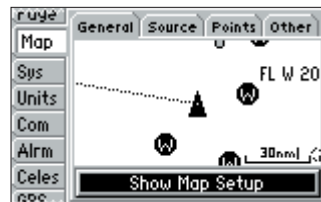
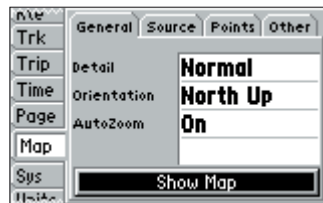

Following are details on each of the settings in the Map setup file tabs:

General Tab

Detail — Most, More, Normal, Less, Least: controls how much map detail you will see. This setting only applies to any map feature set to “Auto.” Those features which have a specified scale or are turned “Off” are unaffected by this setting.

Orientation — North Up: fixes the top of the map display to a north heading; Track Up: fixes the top of the map display to the current track heading; Course Up: fixes the map so the direction of navigation is always “up” and turns the navigation leg line vertical on the screen.

AutoZoom — On/Off: when “On” the map will automatically adjust the map scale to a lower scale as you approach you destination point.

Source Tab

Data — On/Off: turns the loaded map data on or off.

Points Tab — Waypoints, Active Route, Marine Nav aids, and Geo Points

Text — None, Small, Medium, and Large: controls the screen size of the name.

Zoom — Auto, Off, 120 ft.-800 mi.: sets the maximum scale at which the feature should appear on the screen. Some types of data will only show up to certain zoom scales.

Other Tab

Accuracy Circle — On/Off: toggles the circle “On” or “Off.” The circle represents the approximate accuracy of the unit based on EPE and DOP. Your position will be within the circle.

Heading Line — On/Off: turns the Heading Line “On” or “Off.” The Heading Line projects from the triangle (boat icon) showing your current heading.

Bearing Line — Auto, Off, 120 ft.-800 mi.: sets the scale at which the Bearing Line will appear on the screen. The Bearing Line shows the bearing from your current location to a destination waypoint.

Course Line — Auto, Off, 120 ft.-800 mi.: sets the scale at which the Course Line will appear on the screen. The Course Line shows a direct navigation line from the point navigation was initiated to a destination waypoint.

Reference

Map Page Options

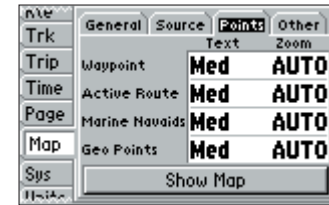

Points Tab

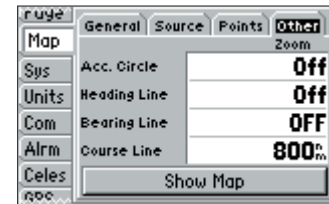

Other Tab

Reference

Map Page Options/ Compass Page



Map Setup Menu Options

Current
Go To

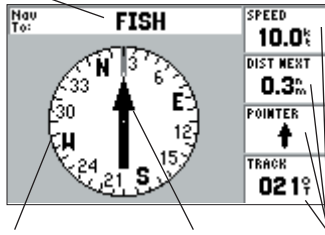

Compass Ring

Bearing Pointer

Data Fields

Map Setup Menu Options

From the map setup page, you can access the following menu options:

- Restore Defaults — restores settings back to factory settings for the selection highlighted.
- Restore All Map Defaults — restores settings back to factory settings for all tabs.

To restore defaults for map settings:

1. From the Map tab in the Main Menu, highlight the tab or setup feature you want to restore settings to and press **MENU**.
2. Highlight 'Restore Defaults' (highlight 'Restore All Map Defaults' if you want all tabs restored) and press **ENTER/MARK**.

Compass Page

Whenever a **NAV/MOB**, Follow Track (TracBack) or Follow Route has been activated, the GPS 152's Compass Page will guide you to your destination with digital readouts and a graphic compass display, which includes a bearing pointer. Use this page (instead of the Highway Page) when travelling at slower speeds, when making frequent directional changes, or where straight-line navigation is not possible due to obstructions or terrain.

The middle of the page features a rotating 'compass ring' that shows your course over ground (track) while you're moving. Your present course over ground is indicated at the top of the compass ring. A bearing pointer, in the middle of the compass ring, indicates the direction of the destination (bearing) relative to the course over ground. The compass ring and pointer arrow work independently to show—at a glance—the direction of your movement and the direction to your destination. For instance, if the arrow points up, you are going directly to the waypoint. If the arrow points any direction other than up, turn toward the arrow until it points up, then continue in that direction.



The bearing pointer and/or compass ring may point in various directions when you are stationary or at very low speeds. Once you start moving, the pointer will be correct.

The GPS 152's Compass Page features a menu page that provides access to data field and simulator options. You may start and stop the simulator from this page. The data window, located on the right side of the page, provides a user-selectable layout of various types of useful data. Each data field may be configured to display any one of 28 data options (Change Data Fields). The data window layout may also be altered to change the actual text size of the data displayed (Big/Small Numbers).

To display the Compass Page options:

1. Press **MENU**.

To select a menu option:

1. Use the **ARROW KEYPAD** to highlight the desired option and press **ENTER/MARK**. For detailed instructions on changing the data fields and data text size of the Compass Page, see pages 22-23.

Highway Page

Whenever a **NAV/MOB**, TracBack or route has been activated, the GPS 152's Highway Page will provide digital and graphic steering guidance to the destination. The right side of the Highway Page features user-selectable data fields that display useful navigation data. The middle section of the screen provides visual guidance to waypoints on a graphic highway display. The line down the center of the highway represents your desired track line.

As you head toward your destination, the highway perspective moves to indicate your progress to the waypoint and which direction you should steer to stay on course. If you are navigating a route, the Highway Page shows each route waypoint in sequence connected by a black "road" with a white line down the middle, which is your desired track line. The Highway perspective scale may also be zoomed in or out to display a larger or smaller view of the highway. Five zoom settings are available from 1X to 16X, with a default setting of 8X.

Reference

Compass Page/ Highway Page



Compass Page Menu Options

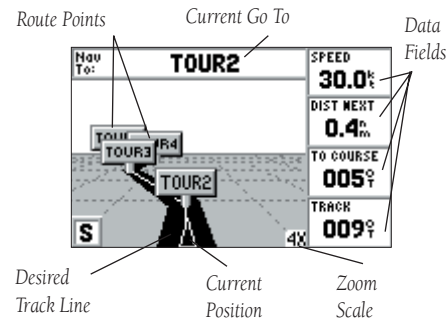

Reference

Highway Page



Highway Page Options Menu

To change the highway perspective scale:

1. Press the **IN** or **OUT** key to select the desired setting.

The GPS 152's Highway options page allows you to define the data fields and select which waypoints are displayed on screen. The data fields, located on the right side of the page, provides a user-selectable layout of various types of useful data. Each data field may be configured to display any one of 28 data options (Change Data Fields). The data field layout may also be altered to change the actual text size of the data displayed (Big/Small Numbers).

The GPS 152's Highway Page features a menu options page that provides access to functions and features relating to the Highway Page and the layout options.

To display the Highway Page options:

1. Press **MENU**.

To select a menu option:

1. Using the **ARROW KEYPAD**, highlight the desired option and press **ENTER/MARK**.

The following options are available from the Highway Page menu:

- **Show/Hide Tracks** — toggles the display of track lines on/off.
- **Big/Small Numbers** — allows you to change the text size and number of data fields that will be displayed. Big Numbers will display three data fields with larger text, and Small Numbers will display four data fields with smaller text.
- **Change Data Fields** — allows you to specify the type of data displayed in each data field used on the display.

For detailed instructions on changing the data fields on the Highway page, see pages 22-23.

Active Route Page

Whenever you activate a route in the GPS 152 system, the Active Route page will show each waypoint of the active route, along with various, user-selectable types of data. For additional details on the Active Route Page, see page 52.

Numbers Page

The Numbers Page allows quick and easy viewing of different types of data in a user-configurable layout. The default page will display four user-selectable data fields showing the ETE (Estimated Time En route) to the next waypoint, speed, turn degree to get you back on course and distance to the next waypoint. You may also choose to show one data field in large lettering for better readability using the 'Big Numbers' option.

The following options are available from the Numbers Page by pressing **MENU**:

- **Big Numbers/Small Numbers** — toggles between one large or four smaller data fields.
- **Change Data Fields** — allows you to specify the type of data displayed in each data field used on the display.

For detailed instructions on changing the data fields and data text size of the Numbers page, see pages 22-23.

Active Route Page/ Numbers Page

GPSMAP TOUR			
Waypoint	Distance	Leg	Dist
TOUR2	1.0 ^m	2.5 ^m	
TOUR3	3.5 ^m	3.1 ^m	
TOUR4	6.6 ^m	9.8 ^m	
TOUR5	16.4 ^m		

TOTALS	16.4^m	16.4^m	

Active Route Page

SPEED
20.0^kt

Numbers Page- Big Numbers

Reference

Creating Waypoints

The screenshot shows the 'New Waypoint' screen with the following fields and buttons:

- Symbol field: 005
- Name field: N 38°51.586'
- Depth field: H094°40.244'
- Depth label: Depth: _____ f
- Buttons: Delete, Map, OK

Press **ENTER/MARK** to use the default name and symbol.

The screenshot shows the 'New Waypoint' screen with the name field highlighted. The fields and buttons are the same as in the previous screenshot.

Highlight a field and press **ENTER/MARK** to enter a new symbol, name or depth.

Creating Waypoints

The GARMIN GPS 152 stores up to 500 alphanumeric waypoints with a user-defined icon and depth available for each waypoint. Waypoints can be created using three basic methods:

- **ENTER/MARK** key – used primarily for marking your present position, the **ENTER/MARK** key also provides options that allow you to select a map position or map item from the map display.
- Graphically – allows you to define a new waypoint position from the map display using the **ARROW KEYPAD**.
- Text Entry – allows you to enter a new waypoint's position coordinates manually (from a chart, etc.).

ENTER/MARK Key

The GARMIN GPS 152's **ENTER/MARK** key lets you quickly capture your present position in order to create a new waypoint. You must have a valid position (2D or 3D) fix to mark your present position. This can be determined by looking at the GPS Main Menu tab.

To mark your present position:

1. Press and hold the **ENTER/MARK** key until the 'New Waypoint' window appears then release it. You will see a default three-digit name and symbol for the new waypoint.
2. To accept the waypoint with the default name and symbol, press **ENTER/MARK** to confirm the highlighted 'OK' prompt.
3. To enter a different name, highlight the name field and press the **ENTER/MARK** key, then use the **ARROW KEYPAD** to enter the new letters/numbers. Press **ENTER/MARK** when done. Note that you may use up to ten alphanumeric characters for the name.
4. To enter a different symbol, highlight the symbol field to the left of the name and press the **ENTER/MARK** key. Use the **ARROW KEYPAD** to highlight the new symbol and press **ENTER/MARK**.

(continued)

Creating Waypoints

- To enter an optional depth, highlight the “Depth” field to the right of the position coordinates and press the **ENTER/MARK** key, then use the **ARROW KEYPAD** to enter a value and press **ENTER/MARK**. If you are receiving valid sonar NMEA input (page 83) , the depth field will automatically fill in. Otherwise, you must manually enter a depth.
- When done, use the **ARROW KEYPAD** to highlight the ‘OK’ prompt and press **ENTER/MARK** to save the waypoint into memory.

Creating Waypoints Graphically

Waypoints may also be quickly created with the Map Page cursor, which allows you to ‘point and shoot’ at any map position or map feature to create a new waypoint. When you move the cursor over a map item, you will see a highlighted description of that item. The GPS 152 will use the map item text shown on the cartography as the default name and symbol.

To create a new waypoint on an open map location (not a map item):

- Use the **ARROW KEYPAD** to move the cursor to the desired map position.
- Press and quickly release the **ENTER/MARK** key to capture the cursor location (pressing and holding the **ENTER/MARK** key will capture the current location, not the cursor’s location).
- The ‘New Map Waypoint’ page will appear. To accept the waypoint with the default name and symbol, highlight ‘OK’ and press **ENTER/MARK**.

To change the name, symbol or enter a depth, highlight the appropriate field and press **ENTER/MARK**. Make your changes and press **ENTER/MARK** when done. After entering and confirming your changes, highlight ‘OK’ and press **ENTER/MARK**.

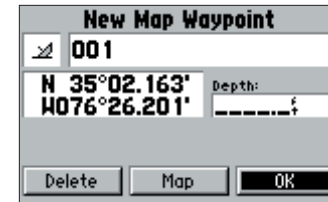

Creating a map waypoint from non-map item.

Reference

Creating Waypoints

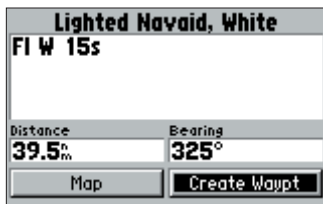

Choose 'Create Waypoint' on the Information page to use the map item for a new waypoint.

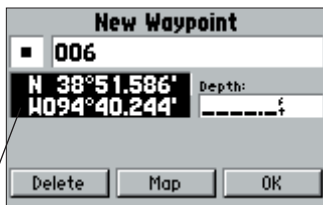

Highlight the position field and use the ARROW KEYPAD to enter the desired position coordinates.

To create a new waypoint from a map feature:

1. Use the **ARROW KEYPAD** to move the cursor to the desired map feature.
2. Press the **ENTER/MARK** key to capture the cursor location. An Information page for that map feature will appear. Use the **ARROW KEYPAD** to highlight 'Create Waypt' and press **ENTER/MARK**.
3. The 'New Waypoint' page will appear. To accept the waypoint with the default name and symbol based on the map feature, highlight 'OK' and press **ENTER/MARK**.

To change the name, symbol or enter a depth, highlight the appropriate field and press **ENTER/MARK**. Make your changes and press **ENTER/MARK** when done. After entering and confirming your changes, move the field highlight back to the 'OK' prompt and press **ENTER/MARK**.

Creating Waypoints By Text Entry

Waypoints may also be created by entering a position's coordinates through the 'Wpt' tab on the main menu page.

To create a new waypoint by entering a location's coordinates:

1. Press **MENU** twice to display the main menu page.
2. Highlight the 'Wpt' tab option and press **MENU**. Then highlight 'New Waypoint' and press **ENTER/MARK**. The 'New Waypoint' page will appear, with the next available waypoint number and the receiver's last known position as the default name and position.
3. To enter coordinates, or change the waypoint name, symbol or enter a depth, highlight the desired field and press **ENTER/MARK**. Use the **ARROW KEYPAD** to enter the new information, and press **ENTER/MARK** after the last character in each section.
4. When you have finished entering all the waypoint data, highlight 'OK' and press **ENTER/MARK**.

Reviewing and Editing Waypoints

Once you have created and stored a waypoint, it may be modified, reviewed, renamed, moved or deleted at any time through the Waypoint Review and Waypoint Edit pages.

To access the Waypoint Review page:

1. Use the **ARROW KEYPAD** to highlight the desired waypoint on the Map Page.
2. Press **ENTER/MARK** to display the Waypoint Review page.

To access the Waypoint Edit page:

1. Press **MENU** twice to view the Main Menu. Use the **ARROW KEYPAD** to highlight the 'Wpt' tab, then highlight the desired waypoint from the 'By Name', 'Nearest' or 'Proximity' lists.
2. Press **ENTER/MARK** to display the Waypoint Edit page.

From the Waypoint Review and Waypoint Edit pages, you may change the name, symbol, position coordinates, or depth for the selected waypoint. Once the changes have been made, highlight 'OK' (Waypoint Review page) or 'Next' (Waypoint Edit page) and press **ENTER/MARK** to save them.

To change the waypoint name:

1. Highlight the waypoint name field and press **ENTER/MARK**.
2. Use the **ARROW KEYPAD** to enter a new name and press **ENTER/MARK** when done.

To change the waypoint symbol:

1. Highlight the waypoint symbol field to the left of the waypoint name and press **ENTER/MARK**.
2. Use the **ARROW KEYPAD** to select the desired symbol and press **ENTER/MARK** when done.

To change the position coordinates:

1. Highlight the position coordinate field and press **ENTER/MARK**.
2. Use the **ARROW KEYPAD** to edit the coordinates. To drop to the next line, press to the right on the **ARROW KEYPAD**. Press **ENTER/MARK** when done.

Editing Waypoints

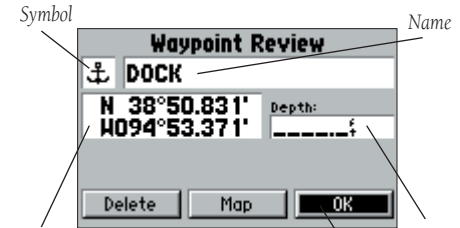

Coordinates

Waypoint Review Page

Select 'OK' to exit/save changes and return to the Map Page.

Depth

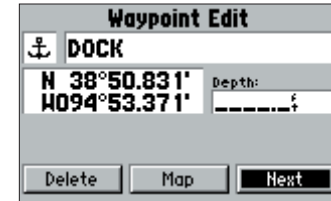

Waypoint Edit Page

Select 'Next' to exit/save changes and return to the next waypoint in the list.

Reference

Editing Waypoints

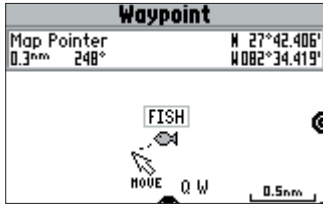

Moving a waypoint on the map.

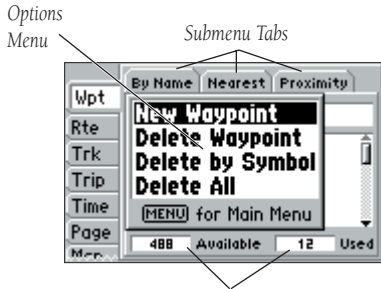

Waypoint List Status

On the Waypoint Review and Waypoint Edit pages, you may also delete the selected waypoint, view the waypoint on the map, and move the waypoint on the map.

To delete a waypoint:

1. On the Waypoint Review/Waypoint Edit page for the selected waypoint, use the **ARROW KEYPAD** to highlight 'Delete' and press **ENTER/MARK**. With 'OK' highlighted, press **ENTER/MARK** again to confirm the deletion.

To view and move the waypoint on the map:

1. From the Waypoint Review/Waypoint Edit page, highlight 'Map' and press **ENTER/MARK**. The waypoint will be displayed on a map screen with an information window at the top that shows the waypoint name, position, and distance and bearing.
2. To move the waypoint, highlight it and press **ENTER/MARK**. A 'MOVE' label will now appear under the cursor arrow. It may be necessary to use the **IN** and **OUT** keys to zoom the map.
2. Use the **ARROW KEYPAD** to move the waypoint to a new position. As you move the cursor around the map display, the information window at the top will change to show position, distance and bearing of the map pointer (the location you're moving the waypoint to). If you wish to stop the move process, press **QUIT**.
3. With the pointer at the desired position, press **ENTER/MARK**. To return to the Waypoint Review/Waypoint Edit page, press **QUIT**.

Waypoint Lists

The GPS 152's Main Menu Page features three waypoint submenu tabs, 'By Name', 'Nearest', and 'Proximity', that let you manage a large number of waypoints quickly and efficiently. The submenu tabs also provide a continuously updated nearest waypoints list and a proximity waypoint alarm function that can be used to define an alarm circle around submerged hazards, shallow waters, etc.

To access the Waypoint submenu tabs of the Main Menu:

1. Press **MENU** twice, then use the **ARROW KEYPAD** to highlight the 'Wpt' tab, and then the desired submenu tab.

'By Name' Waypoints List

The 'By Name' submenu of the Waypoint tab displays a master list of all waypoints currently stored in memory. From the By Name list, you may review, edit, rename or delete individual waypoints, or delete all user waypoints. The total number of stored and available waypoints is displayed at the bottom of the By Name page, with the stored waypoints arranged in numerical/alphabetical order.

To scroll through and review the 'By Name' waypoints list:

1. With the **ARROW KEYPAD**, highlight the 'Wpt' tab from the Main Menu page and then highlight 'By Name'.
2. Use the **ARROW KEYPAD** to scroll through the list in the desired direction.
3. Press **ENTER/MARK** to review the highlighted waypoint on the 'Waypoint Edit' page (see pages 33-34 for detailed information on reviewing and editing waypoints).
4. With 'Next' highlighted, press **ENTER/MARK** to return to the list. The field highlight will automatically move to the next waypoint in the list (you can review details of each waypoint in any waypoint list by pressing **ENTER/MARK** repeatedly).

To display the menu options for the 'By Name' waypoint submenu:

1. Use the **ARROW KEYPAD** to highlight the 'By Name' tab and press the **MENU** key.

The following options are available from the 'By Name' submenu of the 'Wpt' tab:

- New Waypoint — creates a new waypoint (see page 32).
- Delete Waypoint — deletes selected waypoint from list and any route in which it was used.
- Delete by Symbol — deletes waypoints that use the same symbol.
- Delete All — deletes all waypoints from the unit.



Once a waypoint is deleted from the list, it cannot be recovered from the unit. It is advisable to back up important waypoints to a computer using an optional PC cable and interface software or write them down manually.

Waypoint Lists

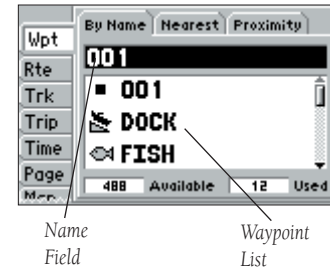

You can also search for a waypoint by name:

1. Highlight the name field and press **ENTER/MARK**.
2. Use the **ARROW KEYPAD** to select the first letter of the name.
3. Move to the **RIGHT** and enter the second letter if you do not see it on the list below.
4. Repeat this until the name appears. Press **ENTER/MARK** when you see the name.
5. Highlight the name on the list and press **ENTER/MARK** again to review the waypoint.

Reference

Waypoint Lists



Delete Waypoint Confirmation Window



Nearest Waypoint List

To delete an individual waypoint from the list:

1. Use the **ARROW KEYPAD** to highlight the waypoint to be deleted and press **MENU**.
2. Highlight 'Delete Waypoint' and press **ENTER/MARK**.
3. With 'OK' highlighted, press the **ENTER/MARK** key to confirm the deletion.

To delete waypoints by symbol:

1. From the 'By Name' tab, highlight the waypoint to be deleted and press the **MENU** key, then select 'Delete By Symbol' and press **ENTER/MARK**.
2. Use the **ARROW KEYPAD** to highlight the symbol of the waypoint(s) to be deleted and press **ENTER/MARK**.
3. Press **ENTER/MARK** to confirm. You may also choose 'Cancel' or press **QUIT** to stop the deletion.

To delete all waypoints or the entire 'By Name' waypoint list:

1. Press the **MENU** key to select the options window.
2. Use the **ARROW KEYPAD** to highlight 'Delete All' and then press **ENTER/MARK**.
3. Highlight the 'OK' prompt and press **ENTER/MARK** to confirm.

Nearest Waypoints List

The 'Nearest' submenu of the Waypoint tab shows the ten nearest waypoints that are within 200 nautical miles of your present position. The nearest waypoints are continuously updated to your present position, and provide quick access to the closest points of safety in emergency situations. The bearing and distance from your present position to each nearest waypoint is displayed in the fields to the right of the list.

Waypoint Lists

To scroll through and review the 'Nearest' waypoint list:

1. With the **ARROW KEYPAD**, highlight the 'Wpt' tab from the Main Menu page and then highlight 'Nearest'.
2. Use the **ARROW KEYPAD** to scroll through the list in the desired direction.
3. Press **ENTER/MARK** to review the highlighted waypoint on the 'Waypoint Edit' page. See page 33-34 for detailed information on reviewing and editing waypoints.
4. With 'Next' highlighted, press **ENTER/MARK** to return to the list. The field highlight will automatically move to the next waypoint in the list. You can review details of each waypoint in any waypoint list by pressing **ENTER/MARK** repeatedly.

Proximity Waypoint List

The 'Proximity' submenu of the Waypoint tab lets you define an alarm circle around a stored waypoint position, and can be used to help you avoid reefs, rocks or restricted waters. Up to ten waypoints may be listed, with a maximum alarm radius of 99.99 nautical miles, statute miles or kilometers. If a proximity alarm circle overlaps with an existing alarm circle, a 'Proximity Overlaps Another Proximity Waypoint' message will appear each time the unit is turned on. If you enter an alarm circle overlap, you will only be alerted to the closest proximity waypoint.

To display the menu options for the 'Proximity' waypoint submenu:

1. Using the **ARROW KEYPAD**, highlight the 'Proximity' tab and press the **MENU** key.

The following options are available from the 'By Name' submenu of the 'Wpt' tab:

- Add Waypoint — adds a waypoint to the proximity list from the waypoint list.
- Clear Alarm — removes selected waypoint from proximity list.
- Clear All — removes all waypoints from proximity list.

Wpt	By Name	Nearest	Proximity
Rte	Proximity Alarm		
Trk	On		
Trip	Waypoint	Distance	
Time	ROCKS	0.60 ^{n.m.}	
Page	SHIPWRECK	0.50 ^{n.m.}	
M-p	PILE	0.10 ^{n.m.}	
	SWIM	0.20 ^{n.m.}	

Proximity Waypoint List

Wpt	By Name	Nearest	Proximity
Rte	Proximity Alarm		
Trk	On		
Trip	Waypoint	Distance	
Time	ROCKS	0.60 ^{n.m.}	
Page	SHIPWRECK	0.50 ^{n.m.}	
M-p	PILE	0.10 ^{n.m.}	
	SWIM	0.20 ^{n.m.}	

Proximity Tab Options Menu

Reference

Waypoint Lists

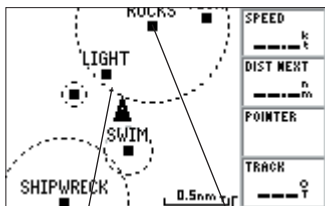

Proximity Circle

Proximity Waypoint

A dashed circle will appear showing the alert boundaries for proximity waypoints.

To add a proximity waypoint:

1. On the Proximity submenu, press **MENU**. Use the **ARROW KEYPAD** to highlight 'Add Waypoint' and press **ENTER/MARK**. The 'Select Waypoint' screen appears.
2. To select a waypoint from the lists, use the **ARROW KEYPAD** to highlight the desired waypoint from the 'By Name' or 'Nearest' waypoint lists. The Waypoint Review page will appear for the selected waypoint. With 'OK' highlighted, press **ENTER/MARK** to confirm.

To select a waypoint from the map, press **MENU**. With 'Select From Map' highlighted, press **ENTER/MARK**. Use the zoom **IN** and **OUT** buttons and the **ARROW KEYPAD** to highlight a waypoint and press **ENTER/MARK**.

3. The waypoint will be added to the Proximity list and the distance field will now be highlighted.
4. Press **ENTER/MARK** to begin entry of the proximity radius and use the **ARROW KEYPAD** to enter a distance value (to 99.99 units). Press **ENTER/MARK** when finished.

To turn proximity alarms on or off:

1. Use the **ARROW KEYPAD** to highlight the field below "Proximity Alarm" and press **ENTER/MARK**.
2. Select the desired 'On' or 'Off' setting and press **ENTER/MARK**.

To clear one or all proximity waypoint(s) from the list:

1. Use the **ARROW KEYPAD** to highlight the proximity waypoint to clear and then press **MENU**.
2. To clear a single alarm, highlight the 'Clear Alarm' field and press **ENTER/MARK**.
3. To clear all proximity waypoints, select the 'Clear All' option and press **ENTER/MARK**.
4. Use the **ARROW KEYPAD** to highlight the 'OK' prompt and press **ENTER/MARK** to confirm.

Going to a Destination

Using the **NAV/MOB** key, the GPS 152 provides four ways to navigate to a destination: Go To Waypoint, Follow Route, Follow Track (TracBack), and MOB (Man OverBoard) navigation. Once you are actively navigating, you will see a straight line that always runs from your current location to the destination. The easiest method is the 'Go To' function, which lets you select a destination waypoint and quickly sets a direct course from your present position. If you have a waypoint highlighted in a list or on the map, 'Go To <waypoint name>' will appear in addition to 'Go To Waypoint'. The 'Go To' function can be accessed from a list of waypoints or graphically from the map display.

To activate a 'Go To' from the waypoint list:

1. Press the **NAV/MOB** key.
2. Use the **ARROW KEYPAD** to highlight 'Go To Waypoint' and press **ENTER/MARK**.
3. To select a waypoint from the waypoint lists, use the **ARROW KEYPAD** to highlight either the 'By Name' or 'Nearest' tab, select a waypoint and press **ENTER/MARK**. With 'Go To' highlighted on the Waypoint Review page, press **ENTER/MARK** to confirm.

To select a waypoint from the map, press **MENU**. With 'Select From Map' highlighted, press **ENTER/MARK**. Use the zoom **IN** and **OUT** buttons and the **ARROW KEYPAD** to select a waypoint, then press **ENTER/MARK**.

To stop navigation:

1. Press the **NAV/MOB** key.
2. Use the **ARROW KEYPAD** to highlight 'Stop Navigation' and press **ENTER/MARK**.

Going to a Destination



Choose a waypoint from the 'By Name' or 'Nearest' tab lists.



Highlight 'Stop Navigation' and press ENTER/MARK to stop navigating.

Reference

Going to a Destination



The waypoint or map item name will automatically appear when highlighted and NAV/MOB is pressed.



'Go To MAP Point' allows you to navigate to a spot on the map which is not a waypoint or map item.

Graphically Selecting a 'Go To'

A graphical 'Go To' may be used to select one of three items from the map display: an existing waypoint, an on-screen map item (roads, rivers, cities, nav aids, etc.), or a new map point (non-map item). If you are selecting a map item as the 'Go To' destination, the GPS 152 will automatically use the name of the map item, but the point will not be stored in the waypoint list. See page 32 for creating waypoints using map features. If you are selecting a new map point (non-map item) as the 'Go To' destination, the GPS 152 will automatically create or move a waypoint named 'MAP' at the cursor position.

To activate an existing waypoint or map item as a 'Go To' from the map display:

1. Use the **ARROW KEYPAD** to highlight the waypoint or map item on screen and press **NAV/MOB**.
2. With 'Go To <waypoint name>' highlighted, press **ENTER/MARK**.

To activate a new map point (non-map item) as a 'Go To' from the map display:

1. Use the **ARROW KEYPAD** to move the arrow cursor to the desired position.
2. Press **NAV/MOB**, you will see 'Go To MAP Point' highlighted, then press **ENTER/MARK**.

To stop navigation:

1. Press the **NAV/MOB** key.
2. Use the **ARROW KEYPAD** to highlight 'Stop Navigation' and press **ENTER/MARK**.

TracBack Navigation (Follow Track)

The second method of navigating to a destination is by using the TracBack feature. TracBack allows you to retrace your path using the track log automatically stored in the receiver's memory, which will eliminate the need to store waypoints along the way. TracBack routes are created by reducing your track log into a route of up to 30 turns and activating an inverted route along those points. Once activated, a TracBack route will lead you back to the oldest stored track log point, so it's good idea to clear the existing track log at the start of your current trip before you get started.

To clear the track log and define a starting point for a TracBack route:

1. Press the **MENU** key twice to display the Main Menu page.
2. Using the **ARROW KEYPAD**, highlight the 'Trk' tab, then highlight the 'Active' tab to the right.
3. Press the **MENU** key, then use the **ARROW KEYPAD** to select the 'Clear' option and press **ENTER/MARK**.
4. Highlight 'OK' on the confirmation screen and press **ENTER/MARK**.

You must first save the track log before you can use the 'Follow Track' feature. The 'Save' feature allows you to store a track from certain times and dates.

To save a track log:

1. From the Main Menu, use the **ARROW KEYPAD** to highlight the 'Trk' tab, then highlight the 'Active' tab to the right.
2. Press the **MENU** key, then use the **ARROW KEYPAD** to select the 'Save' option and press **ENTER/MARK**.
3. From the 'Save Back Through' window, highlight the desired time, date, or 'Entire Log' and press **ENTER/MARK**.
4. The 'Saved Track' window appears with the default name, distance and number of points displayed. Highlight 'OK' and **ENTER/MARK** press to save the track. You may re-name the track and specify whether or not to show the track on the Map and Highway pages. Press the **QUIT** key to exit.

TracBack Navigation



Track Tab



Highlight 'Save' and press ENTER/MARK to save an active track log.

Reference

TracBack Navigation

Default Track name Total number of points

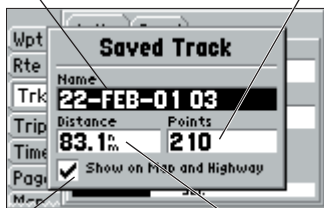

Check this box to display track on the Map and Highway pages. Total Distance



You must first save a track before using the 'Follow Track' option.

To activate a TracBack using the NAV/MOB key:

1. Press the **NAV/MOB** key, then highlight the 'Follow Track' option and press **ENTER/MARK**.
2. Highlight the track you wish to follow and press **ENTER/MARK**.
3. Choose either 'Original', which will navigate you from the end to the start of your trip, or 'Reverse', which will navigate you from the start to the end of your trip and press **ENTER/MARK**.

Once a TracBack has been activated, the GPS 152 takes the track log currently stored in memory and divides it into segments. Up to 30 temporary 'turns' are created (named BEGIN, Turn1, Turn2, Turn3, etc. and END) to mark the most significant features of the track log, duplicating your exact path as closely as possible. To get the most out of the TracBack feature, remember the following tips:

- Always clear the track log at the point that you want to go back to (dock, etc.).
- The 'Record Mode' field on the track log setup page must be set to 'Fill' or 'Wrap'.
- There must be at least two track log points stored in memory to create a TracBack route.
- If the track log interval is set to the 'Time' option, the route may not follow your exact path (keep the interval set to 'resolution' for best performance).
- If the receiver is turned off or satellite coverage is lost during your trip, the TracBack will draw a straight line between any point where coverage was lost and where it resumed.
- If your track's changes in distance and direction are too complex, 30 waypoints may not mark your path accurately. The receiver then assigns the 30 waypoints to the most significant points of your track, and simplifies segments with fewer changes in direction.

To stop TracBack navigation:

1. Press the **NAV/MOB** key.
2. Use the **ARROW KEYPAD** to highlight 'Stop Navigation' and press **ENTER/MARK**.

For more information on setting up the Track options and saved tracks, see pages 54-55.

MOB

The GPS 152's Man OverBoard function (MOB) lets you simultaneously mark and set a course to a position for quick response to emergency situations.

To activate the MOB function:

1. Press and hold the **NAV/MOB** key or press the **NAV/MOB** key twice.
2. Press the **ENTER/MARK** key to confirm and begin navigating to the MOB position.

Once a MOB has been activated, a 'MOB' waypoint with a diver down symbol will be created and the unit will be on an active navigation to that point. Use any of the Navigation Pages to guide you back to the MOB point. The MOB waypoint will be stored in the waypoint list and may be deleted like any other waypoint.

To stop navigation to the MOB position:

1. Press the **NAV/MOB** key.
2. Use the **ARROW KEYPAD** to highlight 'Stop Navigation' and press **ENTER/MARK**.

Reference

MOB: Man OverBoard

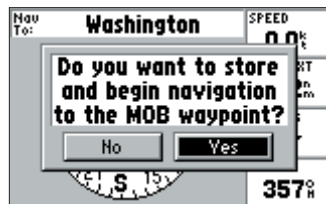

MOB confirmation screen

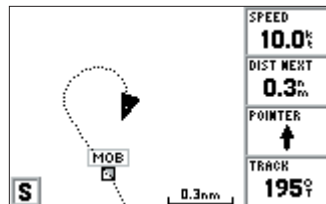

The MOB function allows you to quickly activate a navigation back to a location.

Reference

Creating Routes



Route Tab and Route Options Menu

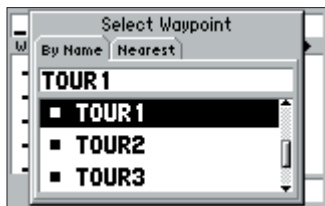

Choose a waypoint from either the 'By Name' or 'Nearest' tab list.

Creating Routes

The last way to navigate to a destination is to create a user-defined route. The GARMIN GPS 152 system lets you create and store up to 20 reversible routes (numbered 1-20), with up to 30 waypoints each. Routes can be created and modified in two ways. One is to 'Edit as Text' from the Route Review page, allowing you to see a list of the waypoints as you create, review, or modify the route. The other is to 'Edit on Map' from the Route Edit map page, allowing you to see each route graphically on-screen as you create, review, or modify the route. All of the GPS 152's route functions are accessed through the Main Menu page or the **NAV/MOB** key.

To create a route using text from the Route Review page:

1. Press the **MENU** key twice to display the Main Menu page.
2. Use the **ARROW KEYPAD** to highlight the 'Rte' tab and press the **MENU** key to display the route options page.
3. Select the 'New Route' option and press **ENTER/MARK**.
4. Use the **ARROW KEYPAD** to highlight the first blank field under the word "Waypoint" and press **ENTER/MARK**.
5. Select a waypoint from the 'By Name' or 'Nearest' tab list and press **ENTER/MARK**. With 'OK' highlighted on the Waypoint Review page, press **ENTER/MARK**.
To select a point from the map, press **MENU**. With 'Select From Map' highlighted, press **ENTER/MARK**. Use the **ARROW KEYPAD** to select a waypoint and press **ENTER/MARK**.
6. The next field down on the list will automatically highlight. Repeat steps 4 and 5 until the desired route points have been entered. Press **QUIT** to return to the Route List page.



Note: To use map items as route points, you will need to either already have them saved as a waypoint or create the route graphically on the Route Edit map page.

To create a route graphically from the Route Edit map page:

1. Press the **MENU** key twice to display the Main Menu page.
2. Use the **ARROW KEYPAD** to highlight the 'Rte' tab and press the **MENU** key to display the route options page.
3. Select the 'New Route' option and press **ENTER/MARK**.
4. Press **MENU**, highlight 'Create on Map' and press **ENTER/MARK**.
5. To add an existing waypoint or map item to the route, use the arrow cursor to highlight the desired waypoint or map item on screen and press **ENTER/MARK**.
6. To add a new waypoint to the route, use the arrow cursor to select the desired map position and press **ENTER/MARK**. Highlight 'OK' and press **ENTER/MARK** again to confirm the new waypoint. You may also change the name and symbol of the new waypoint (see page 33).

As you add each new waypoint to the route, the data window at the top of the map display will show the waypoint/map item name, bearing and distance from your location, and coordinates of the cursor. A route line will appear on the map to indicate each completed leg, and a dotted line will appear to indicate the distance and bearing to the arrow cursor from the last route waypoint.

7. Repeat steps 4 and 5 until you have finished defining all route waypoints.
8. When finished press **MENU**, highlight either 'Edit as Text' to return to the Route Review page, or 'Stop Editing Route' (or press **QUIT**) to return to the Route List page, and press **ENTER/MARK**.

Creating Routes

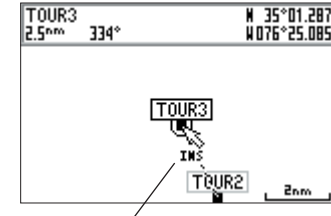

You will see 'INS' below the cursor as you add points.



To stop editing on the map, press MENU and choose one of the above options.

Reference

Route List Page



If you highlight a route name from the Route List and press NAV/MOB, the name will automatically appear.



Route List Menu

Route List Page

The GPS 152 Route List page displays all the routes currently stored in memory, along with a descriptive name for each route. Once a route has been created, it can be activated and used for navigation with the **NAV/MOB** key. A route may be followed in the same sequence as it was originally created, or inverted to navigate from the end waypoint back to the beginning waypoint. From the Route list menu, you may choose 'New Route' (page 44), 'Copy', 'Delete Route', or 'Delete All'.

To activate a route with the NAV/MOB key:

1. From any page, press the **NAV/MOB** key, then using the **ARROW KEYPAD**, highlight 'Follow Route' and press **ENTER/MARK**. (If you highlight a route from the Route List or Route Review page and press **NAV/MOB**, the window will automatically display, 'Follow <the route name>'.)
2. Highlight the route you wish to navigate and press **ENTER/MARK**.
3. Choose 'Activate' or 'Invert and Activate' and press **ENTER/MARK**. 'Activate' will use the route as is, 'Invert and Activate' will reverse the route then activate it.

To deactivate (stop navigation) of a route:

1. Press the **NAV/MOB** key.
2. Use the **ARROW KEYPAD** to highlight 'Stop Navigation' and press **ENTER/MARK**.

To copy a route:

1. From the Route List, using the **ARROW KEYPAD**, highlight the route you want to copy and press **MENU**.
2. Choose 'Copy Route' and press **ENTER/MARK**.

To delete a route:

1. From the Route List, using the **ARROW KEYPAD**, highlight the route you want to delete and press **MENU**.
2. Choose 'Delete Route' and press **ENTER/MARK**.
3. With "OK" highlighted, press **ENTER/MARK** again to confirm the deletion.

To delete all routes:

1. From the Route List, press **MENU**.
2. Highlight 'Delete All' and press **ENTER/MARK**. Highlight "OK" and press **ENTER/MARK** again to confirm the deletion.

Route Review Page

Once you have created a route, the Route Review page allows you to review and modify the route displayed.

To access the Route Review page:

1. Press **MENU** twice, highlight the 'Rte' tab.
2. Highlight the name of the route you wish to review and press **ENTER/MARK**.

The Route Review page allows you to enter a 15-character name for any listed route. By default the name includes the first and last waypoints in the route.

To enter a custom route name:

1. From the Route Review page, highlight the name field and press **ENTER/MARK** to begin editing.
2. Use the **ARROW KEYPAD** to enter the desired name and press **ENTER/MARK** when finished.

The Route Review page displays trip planning information for each leg and for the entire route. One of nine available planning figures appears to the right of each route waypoint and its distance. Available information includes: Course, ETA, Fuel (to point), Leg Distance, Leg Fuel, Leg Time, Sunrise and Sunset (at point location) and Time To (point). Totals for distance and the data fields are displayed at the bottom of the page.

To view the trip planning data fields:

1. From the Route Review page, use the **ARROW KEYPAD** to highlight a waypoint from the list.
2. Press RIGHT or LEFT on the **ARROW KEYPAD** to view the desired data field.

Route Review Page

Route Name

Data Fields

Waypoint	Distance	Course
TOUR 1	0.0 ^m	007 [°]
TOUR2	2.3 ^m	334 [°]
TOUR3	4.8 ^m	005 [°]
TOUR4	7.9 ^m	329 [°]
TOUR5	17.7 ^m	341 [°]
Route Points		Data Totals

Route Review Page

Waypoint	Distance	Course
TOUR5	0.0 ^m	149 [°]
TOUR4	9.8 ^m	185 [°]
TOUR3	12.9 ^m	154 [°]
TOUR2	15.4 ^m	187 [°]
TOUR1	17.7 ^m	161 [°]

Press **LEFT** or **RIGHT** on the **ARROW KEYPAD** to change the data displayed in this column.

Reference

Route Review Page

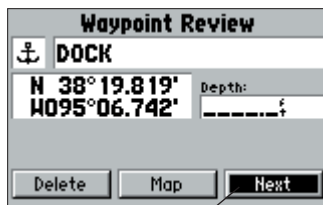

Highlight 'Next' and press ENTER/MARK to view the next route point.

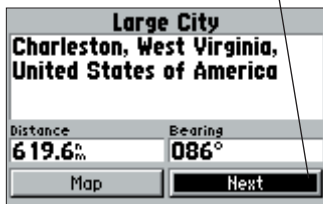

On the Route Review page, you may review the route points (waypoints or map items) one at a time from the list:

To review individual route points:

1. Highlight the desired point and press **ENTER/MARK**.
2. If the point is a waypoint, the Waypoint Review page will appear. You may edit the waypoint name, symbol, coordinates, and depth (see page 33 for more information on editing waypoints). Use the **ARROW KEYPAD** to choose 'Delete' (permanently delete the waypoint from the unit), 'Map' (view the waypoint on the map), or 'Next' (exit the Waypoint Review page and highlight the next point on the route list). Press **ENTER/MARK** when finished.

If the point is a map item, the Information page for that feature will appear. Use the **ARROW KEYPAD** to select 'Map' (view the item on the map) or 'Next' (exit the Information page and highlight the next point on the route list). Press **ENTER/MARK** when finished.

Once you are back on the route point list, the next point in the route will automatically be highlighted. This allows you to review each point on the route by pressing **ENTER/MARK** repeatedly.

Route Review Page Menu Options

Pressing **MENU** on the Route Review page will display the following menu options: Edit on Map, Insert/Add Waypoint, Remove Waypoint, Invert, Plan Route, and Delete Route.

Edit on Map — This option allows you to review and modify the route while it is displayed on a map page. You may use the map cursor to insert, delete and review route points.

To edit the route on the map:

1. From the Route Review page, press **MENU**, highlight 'Edit on Map' and press **ENTER/MARK**.

To edit a route point:

1. Use the **ARROW KEYPAD** to highlight the desired route waypoint and press **ENTER/MARK**.

A pop-up menu of editing choices will appear, with options for reviewing, removing, moving, centering the map on the next point or adding turns to the beginning or end of the route.

Editing Routes

To review a route point:

1. Highlight the 'Review' option and press **ENTER/MARK**. The Waypoint Review page will appear if the route point is a waypoint, and the Information page will appear if the route point is a map item. with 'OK' highlighted, press **ENTER/MARK** again when done.

To remove a route point:

1. Highlight the 'Remove' option and press **ENTER/MARK**.

To move a route point:

1. Highlight the 'Move' option and press **ENTER/MARK**. The word "MOVE" will appear below the cursor, and a dashed extension line will stretch as you move the cursor.
2. Use the **ARROW KEYPAD** to move the cursor to the new map position and press **ENTER/MARK**.

To center the map on the next route point:

1. Highlight the 'Next' option and press **ENTER/MARK**.

To add turns at the beginning or end of the route:

1. Select the first (to add waypoints to the beginning of the route) or last (to add waypoints to the end of the route) route waypoint with the map cursor, and press **ENTER/MARK**.
2. Highlight the 'Add Turns' option and press **ENTER/MARK**. The letters "INS" will appear below the cursor, and a dashed extension line will stretch as you move the cursor.
3. Use the **ARROW KEYPAD** to move the cursor to the new point or position and press **ENTER/MARK**.
4. If you are not inserting an existing waypoint or map feature, press **ENTER/MARK** to confirm the new waypoint.
5. Repeat steps 3 and 4 to insert additional waypoints, or press **QUIT** to finish.



Route Review Options Menu



Choose 'Review' to display the point details.

Reference

Editing Routes

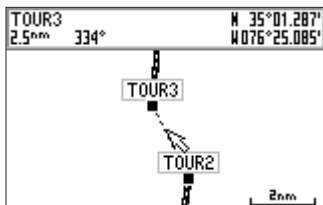

Highlight the route leg on which you wish to insert a waypoint and press **ENTER/MARK**.

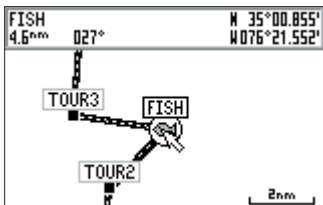

Drag the route leg to an existing waypoint (shown), map item, or a blank spot on the map to create a new route point.

The GPS 152's Edit on Map mode also allows you to insert a new route waypoint in any route leg using the map cursor.

To insert a new point between two existing route waypoints:

1. Use the **ARROW KEYPAD** to select the leg on which you want to insert the new waypoint (the route leg will highlight and change to a dotted line when the leg is selected) and press **ENTER/MARK**. The letters "INS" will appear below the cursor and the route leg will stretch as you move the cursor.
2. Use the **ARROW KEYPAD** to move the cursor to the desired new map position, existing waypoint, or map item and press **ENTER/MARK**.
3. If you are not inserting an existing point or map item, press **ENTER/MARK** to confirm the new waypoint.

Insert/Add Waypoint — Allows you to insert a waypoint into the list of route points or add a point(s) onto the end of the route.

To insert a point into the route or add a point to the end:

1. From either the Route Review or Active Route pages, use the **ARROW KEYPAD** to highlight the point you wish to insert the new point before (To add a point to the end, highlight the blank field at the bottom of the list) and press **MENU**.
2. Highlight 'Insert Waypoint' or 'Add Waypoint' and press **ENTER/MARK**.
3. From either the "By Name" or Nearest" tab lists, highlight the waypoint to be inserted/added and press **ENTER/MARK**.

To select a waypoint from the map, press **MENU**. With 'Select From Map' highlighted, press **ENTER/MARK**. Use the zoom **IN** and **OUT** buttons and the **ARROW KEYPAD** to highlight a waypoint on the map and press **ENTER/MARK**.

Remove Waypoint — Allows you to remove a point (waypoint or map item) from a route. This option is available from both the Route Review and Active Route pages.

Editing Routes

To remove a point from a route:

1. From the Route Review or Active Route pages, use the **ARROW KEYPAD** to highlight the point to remove and press **MENU**.
2. Highlight 'Remove Waypoint' and press **ENTER/MARK**.

Invert — The Invert function will reverse the route you choose.

To invert a route:

1. From the Route Review page or Active Route page, press **MENU**.
2. Using the **ARROW KEYPAD**, highlight 'Invert' and press **ENTER/MARK**.

Plan Route — The Route Review and Active Route pages also display trip-planning information for the entire route.

To use the Plan Route feature:

1. From the Route Review or Active Route page, press **MENU** and select 'Plan Route'.
2. Enter the desired figures for Speed, Fuel Flow, Depart(ure) Time, and Depart(ure) Date. Press **QUIT** to return to the Route Review or Active Route page.



Fuel flow rates on your unit are measured in "units per hour." System setting changes for units of measure (statute, nautical or metric) do not affect the fuel flow measure. You should enter fuel flow rates based upon available information for your vehicle (operator's manual, performance specifications, etc.) and make note of the desired units of measure (gallons, liters, etc.).

Delete Route — Deletes route and any map item points within route.

To delete a route:

1. From the Route Review page press **MENU**.
2. Highlight 'Delete Route' and press **ENTER/MARK**. With 'OK' highlighted, press **ENTER/MARK** to confirm the deletion.

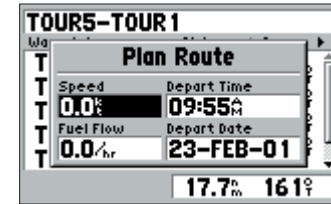

Plan Route Data Fields

Reference

Active Route Page

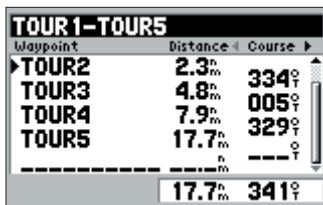

Waypoint	Distance	Course
TOUR2	2.3 ^m	334 ^o
TOUR3	4.8 ^m	005 ^o
TOUR4	7.9 ^m	329 ^o
TOUR5	17.7 ^m	---

	17.7 ^m	341 ^o

Active Route Page



TOUR	Edit on Map	Course
Waypoint	Insert Waypoint	
TOU	Remove Waypoint	07 ^o
TOU	Invert	34 ^o
TOU	Plan Route	05 ^o
TOU	Re-evaluate	29 ^o
S	[MENU] for Main Menu	41 ^o

Active Route Page Menu Options

Active Route Page

When you have activated a route in the GPS 152 system, the Active Route page shows each point (waypoint or map item) of the active route, with the point name, distance and choice of selectable data fields for each point from your present position (just like the Route Review page). The current destination point, the 'active' point, is marked with an arrow icon. As you navigate a route, the waypoint list will automatically update to indicate the next 'active' point first. The Active Route and Route Review pages share many of the same features and options.

The following options are available by pressing **MENU** on the active route page:

- Edit on Map— see pages 48-50 for instructions.
- Insert/Add Waypoint— see page 50 for instructions.
- Remove Waypoint— see pages 50-51 for instructions.
- Invert— see page 51 for instructions.
- Plan Route— see page 51 for instructions.
- Re-evaluate— recalculates and reactivates the current route data.

Re-evaluate— Reactivates the current route and selects the route leg closest to your current position as the active leg. The active leg defines the current 'from' and 'to' waypoints.

To Re-evaluate an active route:

- 1 From the Active Route page, press **MENU**.
2. Using the **ARROW KEYPAD**, highlight 'Re-evaluate' and press **ENTER/MARK** to recalculate.

Main Menu Page

The GPS 152's Main Menu Page provides access to various waypoint, system, navigation and interface management, and setup menus in an easy to use "tab" format. The Main Menu page is available from any page in the GPS 152's system, and is accessed through the **MENU** key. See pages 2-3 for additional instructions changing settings and entering data.

To access the Main Menu Page:

1. Press **MENU** twice.

To select a menu tab from the Main Menu page:

1. Move the **ARROW KEYPAD** UP or DOWN to highlight the tab you want to view. The information for the highlighted tab will automatically appear to the right.
2. If you want to highlight any of the tab items, press to the RIGHT on the **ARROW KEYPAD**, then move UP or DOWN to select individual items.
3. You may then press either **MENU** for additional submenu options or press **ENTER/MARK** to make changes to the highlighted item.
4. Press LEFT on the **ARROW KEYPAD** to get back to the Menu tab list. Pressing **QUIT** will take you out of the Main Menu page.

The following describes the functions of the 14 Main Menu tabs:

- Wpt (Waypoint) — Allows you to create, edit or delete waypoints. See pages 32-38.
- Rte (Route) — Allows you to create, edit, activate or delete routes. See pages 44-51.
- Trk (Track) — Lets you record a track, define how it is recorded and displayed.
- Trip — Provides trip speeds, odometers, averages, and trip timers.
- Time — Sets up time format, time zones, and daylight savings.
- Page — Enables main pages to be turned on, off or 'jumped to'.
- Map — Sets up Map Page features, zooms, and text size. See pages 24-26.
- Sys (System) — Defines beeper, simulator and language, restores setup, and displays software version.

Reference

Main Menu

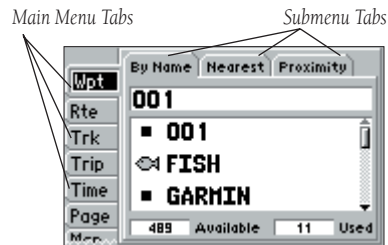

Main Menu Page

Reference

Main Menu: Track Tab



Active Track Tab

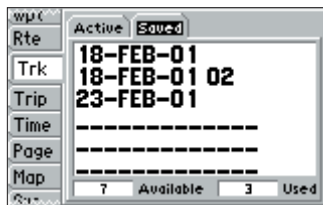

Saved Track Tab

- Units — Defines position format, datum, heading, and units of measure.
- Com (Communication)— Has interface settings for use with a PC or second device.
- Alm (Alarm)— Sets up alarms for anchor drag, arrival, off course, and clock.
- Celes (Celestial) — Shows sun/moon time cycles and positions.
- GPS — Shows satellite status, accuracy, control simulator, initialize position.
- Tide — Displays 12 hour tide chart with levels and times.

Trk (Track) Tab — Lets you specify whether or not to record a track log (an electronic 'bread crumb trail' recording of your path), define how it is recorded, or save track log data for future use. The Track Log Page also provides an indicator of the memory used for the active track log and options to clear the track memory or start a TracBack route. See pages 41-42 for TracBack information. The Track submenu is divided in two tabs: the 'Active' tab and the 'Saved' tab.

The 'Active' tab is for the active log (the log currently being recorded). It displays track memory used and current settings.

The 'Saved' tab displays and manages a list of any saved tracks, allows TracBack activation, map display of saved tracks. The active log stores up to approximately 2000 track log points, based upon the criteria specified in the Track settings. Up to 10 track logs may be saved in memory, with up to 250 track log points in each saved log.

For the 'Active' tab, the following settings are available:

- Record Mode — Lets you select one of three track recording options:
 - Off — No track log will be recorded. Note that selecting the 'Off' setting will prevent you from using the TracBack feature.
 - Fill — A track log will be recorded until the track memory is full.
 - Wrap — A track log will be continuously recorded, wrapping through the available memory (replacing the oldest track data with new data).

Reference

Main Menu: Track Tab

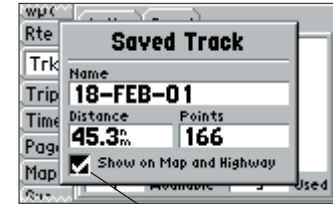

Use the 'Show Map' option to display a saved track.



The track name will automatically appear when highlighted on the 'Saved' list and NAV/MOB is pressed.

- Interval — Defines the frequency for recording the track plot. Three interval settings are available:
 - Time — Records track plot based on a user-defined time interval.
 - Resolution — Records track plot based upon a user-defined variance from your course over ground. The resolution option is the default setting and is recommended for the most efficient use of memory and TracBack performance. The distance value (entered in the value field) is the maximum error allowed from the true course before recording a track point.
 - Distance — Records track based on a user-defined distance between points.

- Value — Defines the distance or time used to record the track log.

For the 'Active' tab, the following options are available by pressing **MENU**:

- Save — Allows you to save the current active track log.
- Clear — Allows you to clear the active track log currently stored in memory.

For the 'Saved' tab, the following options are available by pressing **MENU**:

- Show Map — Displays the saved track log on a Track Map page.
- Delete Track — Deletes highlighted saved track from memory.
- Delete All — Deletes all saved tracks from memory.

You may also activate a TracBack from any of the saved tracks on this tab.

To activate a TracBack from the 'Saved' tab list:

1. Using the **ARROW KEYPAD**, highlight the track you wish to use for a TracBack and press **NAV/MOB**.
2. The 'Follow <track name>' will automatically appear highlighted. Press **ENTER/MARK**.
3. Choose either 'Original', which will navigate you from the end to the start of your trip, or 'Reverse', which will navigate you from the start to the end of your trip and press **ENTER/MARK**.

Reference

Main Menu: Trip, Time and Pages Tabs

WMC	Trip Odometer	Stopped Time
Rte	0.0%	00:00:00
Trk	Moving Average	Moving Time
Trip	0.0%	00:00:00
Time	Total Average	Total Time
Page	0.0%	00:00:00
Map	Maximum Speed	Odometer
	0.0%	0.0%

Trip Tab

WMC	Time Format	
Rte	12 Hour	
Trk	Time Zone	
Trip	Central	
Time	Daylight Savings Time	
Page	Auto	
Map	Current Time and Date	
	10:21:43	23-FEB-01

Selectable
Data Fields

Non-Selectable
Data Field

Time Tab

Trip Tab — Displays Trip Odometer, Moving Average speed, Total Average speed, Maximum Speed, Stopped Time, Moving Time, Total Time, and Odometer.

To reset data in the Trip tab:

1. Press **MENU**, then highlight 'Reset Trip', 'Reset Odometer', 'Reset Max Spd (speed)', or 'Reset All' and press **ENTER/MARK**.

Time Tab — Displays the current time and date, allows you to select the 12 or 24 hour time format, enter a time zone and adjust for daylight savings to show correct local time.

The following settings are available:

- Time Format — Choose from 12 or 24 hour (military) time format.
- Time Zone — Choose your correct time zone to show correct local time or enter a UTC Offset. The UTC (also called Greenwich Time) offset is how many hours you are ahead or behind the time line. See the table on page 72 for time offsets.
- Daylight Savings Time — Choose from 'Auto', 'On', or 'Off' to adjust for daylight savings.

Page Tab — Allows you to turn the display of the main pages on/off or 'Jump To' a particular page.

To select/deselect a main page:

1. Use the **ARROW KEYPAD** to highlight the box to the left of the page name. Pressing **ENTER/MARK** will select/deselect that page. When a page is selected a '✓' will appear in the box. You must leave at least one page checked.

The following options are available by pressing **MENU**:

- Enable All Pages — Selects all pages.
- Basic Trackplotter — Selects Map page only.
- Nav Tools Only — Selects Compass, Highway, and Active Route pages only.

To 'Jump To' a specific page:

1. Use the **ARROW KEYPAD** to highlight the 'Jump To' option to the right of the desired page and press **ENTER/MARK**.

Map Tab — See pages 24-26.

Sys (System) Tab — Controls system setting for beeper, speed filter, languages, system mode, simulator controls, restores factory settings, and displays software version.

The following settings are available:

- **Beeper** — Controls audible beep. Select from 'Off', 'Alarms Only' (sounds for alarms/messages), 'Key and Alarm' (sounds for key presses and alarms/messages).
- **Speed Filter** — Averages speed-readings. Choose from 'Off', 'Auto' (automatically controls filtering), or 'On' (allows you to enter a value from 1 to 255 seconds).
- **Language** — Select from 11 languages for display on the unit.
- **System Mode** — Select from 'Normal' (Normal Navigation) or 'Simulator' (For practice ONLY)

When the unit is in Simulator mode, the 'Set Options' button will appear next to the System Mode field.

To view the 'Set Options' window:

1. With the unit in Simulator mode, use the **ARROW KEYPAD** to highlight the 'Set Options' button and press **ENTER/MARK**.

The following settings are available in the 'Set Options' window of the System Tab:

- **Track Control** — 'Auto Track' will steer to the current navigation point. 'User Track' allows you to enter a heading in the 'Track' field to the right.
- **Speed** — Lets you enter a speed.
- **Track** — Lets you enter a heading.
- **Set Position** — Allows to set your location while in simulator mode. See page 11, starting with step 2, for additional instructions.

The following options are available by pressing **MENU** on the System tab:

- **Restore Garmin Setup** — Restores ALL settings to GARMIN's original setup values for the entire unit.
- **Software Version** — Displays the unit's software and Unit ID. For registering the GPS 152, use the printed serial number on the bottom of the unit.

Reference

Main Menu: System Tab



Page Tab



System Tab

Reference

Main Menu: Units Tab



The Units tab settings will affect how navigation information is displayed on the GPS 152. When in doubt, seek assistance.

If you are using a map or chart in conjunction with your GPS, make sure the settings under the 'Units' tab of the GPS 152 match that of the map or chart. This information should be displayed somewhere on the map or chart. If the information is not present, contact the map or chart maker to determine what position format, datum, heading and units of measure are being used for the map or chart.

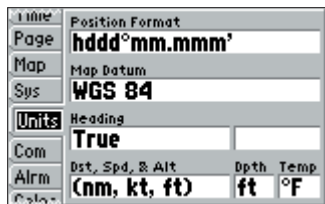

Units Tab

Units Tab — Defines Position Format, Map Datum, Heading, Distance, Speed, Altitude, Depth and Temperature.

The following settings are available:

- Position Format — Used to change the coordinate system in which a given position reading is displayed. You should only change the position format if you are using a map or chart that specifies a different position format or wish to use a format you are familiar with. The default format is latitude and longitude in degrees, minutes, and thousandths of a minute (hddd°mm.mmm'). The following additional formats are also available:
 - hddd.ddddd° — latitude/longitude in decimal degrees only
 - hddd°mm'ss.s" — latitude/longitude in degrees, minutes, seconds
 - UTM/UPS — Universal Transverse Mercator / Universal Polar Stereographic grids
 - British Grid
 - Dutch Grid
 - Finnish KKJ27
 - German Grid
 - India Zone O
 - India Zone IA
 - India Zone IB
 - India Zone IIA
 - India Zone IIB
 - India Zone IIIA
 - India Zone IIIB
 - India Zone IVA
 - India Zone IVB
 - Irish Grid
 - Maidenhead
 - MGRS
 - New Zealand
 - Qatar Grid
 - RT 90
 - Swedish Grid
 - Swiss Grid
 - Taiwan Grid
 - Loran TD (see pages 70-71 for Loran TD setup)
 - User Grid
 - W Malayan RSO
- Map Datum — Allows you to select the datum reference used to determine a given position. The default setting is 'WGS 84'. Datums are used to describe geographic positions for surveying, mapping, and navigation and are not actual maps built in the unit. Although over 100 datums are available (as listed on pages 75-76), you should only change the datum if you are using a map or chart that specifies a different datum.



WARNING: *Selecting the wrong map datum can result in substantial position errors. When in doubt, use the default WGS 84 datum for best overall performance.*

Main Menu:
Units Tab

- **Heading**— lets you select the reference used in calculating heading information. You can select from 'Auto Mag Var', 'True', 'Grid' and 'User Mag Var'. 'Auto Mag Var' provides magnetic north heading references which are automatically determined from your current position. 'True' provides headings based upon a true north reference. 'Grid' provides headings based on a grid north reference (and is used in conjunction with the grid position formats described on page 58). 'User Mag Var' allows you to specify the magnetic variation at your current position and provides magnetic north heading references based upon the variation you enter.

To enter a user defined magnetic variation:

1. With the 'Heading' field set to 'User Mag Var', highlight the heading reference field (immediately to the right) and press **ENTER/MARK**.
2. Use the **ARROW KEYPAD** to enter the magnetic variation at your current position and press **ENTER/MARK**.



WARNING: *If 'User Mag Var' is selected, you must periodically update the magnetic variation as your position changes. Using this setting, the unit will not automatically calculate and update the magnetic variation at your present position. Failure to update this setting may result in substantial differences between the information displayed on your unit and external references, such as a magnetic compass.*

- **Distance, Speed and Altitude**— lets you select the desired units of measure for distance, speed and altitude readouts in 'Nautical' (nm, kt, ft), 'Statute' (mi, mh, ft) or 'Metric' (km, kh, mt) terms.
- **Depth***— lets you select the desired units of measure for depth in Feet (ft), Fathoms (fa) or Meters (mt).
- **Temperature***— lets you select the desired units of measure for temperature in Fahrenheit (°F) or Celsius (°C).

* You must be receiving proper sonar NMEA data from another device for this data to display. See pages 83-84.

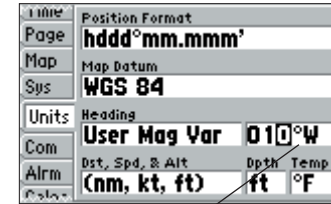

You may manually enter a magnetic variation.

Reference

Main Menu: Com Tab

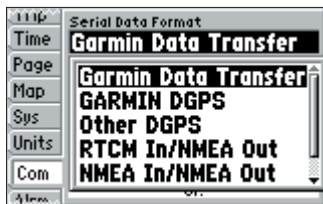

Com Tab Serial Data Formats



Com Tab Transfer Modes

Com (Communication) Tab — Lets you control the input/output format used when connecting your GPS 152 to external NMEA devices, a DGPS beacon receiver, a personal computer, another Garmin GPS 152, etc. Six format settings are available for serial data transfer:

- **Garmin Data Transfer** — The proprietary format used to upload/download MapSource data, exchange waypoint, route, track, almanac, and proximity data with a PC or another GARMIN GPS 152. When you select 'Garmin Data Transfer', there are 11 Transfer Modes to choose from: Host, Request Almanac, Request Proximity, Request Routes, Request Tracks, Request Waypoints, Send Almanac, Send Proximity, Send Routes, Send Tracks and Send Waypoints.
- **GARMIN DGPS** — Used to connect the GPS 152 with a Garmin differential GPS (DGPS) beacon receiver.
- **Other DGP S**— Provides input only interfacing capabilities for 3rd party DGPS receivers.
- **RTCM In/NMEA Out** — Allows DGPS input using a standard RTCM format, and also provides NMEA 0183 version 2.3 output.
- **NMEA In/NMEA Out** — Supports the input/output of standard NMEA 0183 version 2.3 data, and sonar NMEA input support for the DPT, MTW and VHW sentences (see page 84 for information on Advanced NMEA setup).
- **None** — Provides no interfacing capabilities.

To select an input/output format:

1. Highlight the 'Serial Data Format' field and press **ENTER/MARK**.
2. Use the **ARROW KEYPAD** to select the desired setting and press **ENTER/MARK**.

To select a transfer mode:

1. Use the **ARROW KEYPAD** to select 'Garmin Data Transfer' in the 'Serial Data Format' field.
2. Highlight the 'Transfer Mode' field and press **ENTER/MARK**.
3. Use the **ARROW KEYPAD** to select the desired setting and press **ENTER/MARK**.

To restore the Serial Data Format settings back to the default 'Garmin Data Transfer':

1. From the Com Tab, press **MENU**, highlight 'Restore Defaults' and press **ENTER/MARK**.

If the 'Garmin DGPS' format is selected, additional fields are provided to control a GARMIN differential beacon receiver directly from your GPS 152. You may have the unit automatically scan for the DGPS beacon signal or you can enter the beacon frequency and bit rate on the unit and the information will be used to tune the beacon receiver.

To have the unit automatically scan for a frequency:

1. With the unit set to 'Garmin DGPS', use the **ARROW KEYPAD** to highlight the "Beacon" field and press **ENTER/MARK**.
2. Highlight 'Scan' and press **ENTER/MARK**. The numbers in the "Frequency" field will change as the unit scans from 284 kHz to 325 kHz, 200 bit rate, then 100, at 6-second intervals.

To restart the scan:

1. Press **MENU**, highlight 'Restart Scan' and press **ENTER/MARK**.

To manually enter a frequency and bit rate:

1. With the unit set to 'Garmin DGPS', use the **ARROW KEYPAD** to highlight the "Beacon" field and press **ENTER/MARK**.
2. Highlight 'User' and press **ENTER/MARK**.
3. Highlight the "Frequency" or "Bit Rate" field, press **ENTER/MARK**, then enter a frequency or bit rate and press **ENTER/MARK** when done.

The "Status" field will show one of the following:

- Tuning — Unit is attempting to tune to the specified frequency and bit rate.
- Scanning — Unit is automatically scanning through the frequencies and bit rates.
- Receiving — Unit is receiving DGPS signal and ready for operation.
- Check Wiring — Unit is not making connection with DGPS receiver.

When the unit is receiving a DGPS signal, the "SNR" (Signal to Noise Ratio) and "Distance" fields will show data. The SNR range is 0dB to 30dB, with 30 being the best. The "Distance" field may or may not show data, depending upon the signal being broadcast from the DGPS site.

Main Menu: Com Tab

Time	Serial Data Format		
Page	GARMIN DGPS		
Map	Baud	Status	
Sys	4800	Tuning	
Units	Beacon	Bit Rate	Frequency
Com	User	200	286.0kHz
Alerts	SNR	Distance	
	---	---	---

You may also manually enter a frequency and bit rate.

Time	Serial Data Format		
Page	GARMIN DGPS		
Map	Baud	Status	
Sys	4800	Scanning...	
Units	Beacon	Bit Rate	Frequency
Com	Scan	200	284.0kHz
Alerts	SNR	Distance	
	---	---	---

SNR and Distance will show data when signal is received.

Reference

Main Menu: Com and Alarm Tabs

Time	Anchor Drag	Off	0.00 _m
Page	Arrival	Time	00:00:15
Map	Off Course	Off	0.00 _m
Sys	Clock	Off	12:00 _m
Units	Shallow Wtr	Off	20.0 _f
Com	Deep Water	Off	100.0 _f
Alarm			
Display			

Alarm Tab

Time	Anchor Drag	Off	0.00 _m
Page	Arrival	Time	00:00:15
Map	Off Course	Off	0.00 _m
Sys	Clock	On	10:30 _m
Units	Shallow Wtr	Off	20.0 _f
Com	Deep Water	Off	100.0 _f
Alarm			
Display			

Alarm Clock ENTER

Press ENTER/MARK to acknowledge an alarm.

The DGPS beacon transmitters are operated by the U.S. Coast Guard (or similar government agency in other countries), which is responsible for their accuracy and maintenance. For DGPS transmitter problems or to find the most updated list of frequencies and coverage areas, contact your local USCG (or foreign equivalent), or see their web site at <http://www.navcen.uscg.mil/>.

Alarm (Alarm) Tab — Allows you to define the alarm settings for Anchor Drag, Arrival, Off Course, Clock, Shallow Water and Deep Water.

- Anchor Drag — Sets an alarm to sound when you've exceeded a specified drift distance. Enter a distance up to 9.99 miles or kilometers in the distance field and use the control field to turn the alarm on and off.
- Arrival — Sets an alarm to sound when you're a specified distance or time away from a destination waypoint. Enter a distance radius or time for sounding the alarm and use the control field to set the alarm to 'Off', 'Dist' (Distance), or 'Time'.
- Off Course — Sets an alarm to sound when you're off a desired course by a specified distance. Enter a distance in the distance field and use the control field to turn the alarm on and off.
- Clock — Provides an alarm for the system clock. Enter a time in the time field and turn the alarm on and off from the control field menu. Remember to enter alarm times in the same time format (UTC or local) you're using for your system. The unit must be on for the clock alarm to work.
- Shallow Water/Deep Water* — Set alarms to sound when you enter an area of specified depth that is too shallow and/or too deep. Enter a depth in the distance fields and use the control fields to turn the alarms on and off.

* You must be receiving sonar NMEA data for this function to work (see pages 83-84).

To set an alarm:

1. Use the **ARROW KEYPAD** to highlight the field to the right of the alarm name you wish activate and press **ENTER/MARK**.
2. Change the mode to 'On' (Dist or Time for the 'Arrival' alarm) and press **ENTER/MARK**.
3. Highlight the next field to the right and press **ENTER/MARK**, then enter the desired settings and press **ENTER/MARK** to finish.

Celes (Celestial) Tab — Displays celestial data for sun and moon rise/set, moon phase, and the approximate sky view location of the sun and moon. The moon phase will display the current visible portion of the moon as a light color. You may display this data for your current position, a position from the map, or a waypoint location. You may also select a different date and/or time, and change the sky view orientation to 'North Up' or 'Track Up'.

To choose a position:

1. From the Celes tab, use the **ARROW KEYPAD** to highlight 'Current Position' and press **ENTER/MARK**.
2. Choose 'Use Current Position', 'Choose Position From Map', or 'Choose Waypoint' and press **ENTER/MARK**.
3. For 'Choose Position From Map', use the **ARROW KEYPAD** and **IN & OUT** zoom keys to select a position on the map and press **ENTER/MARK**.

For 'Choose Waypoint', use the **ARROW KEYPAD** to select a waypoint from the 'By Name' or 'Nearest' tab lists and press **ENTER/MARK**, then **ENTER/MARK** again to confirm.

The location the unit is using will appear in the Date/Time/Position field. The timetables displayed will be based on the time zone of your current position. When using a position from another location outside of your time zone, you will need to change the time zone to match that location under the Time Tab on the Main Menu (see page 56).

To display celestial data for a different date and/or time:

1. From the Celes tab, use the **ARROW KEYPAD** to highlight the date or the time field and press **ENTER/MARK**. Use the **ARROW KEYPAD** to enter a new date and/or time and press **ENTER/MARK**.
2. To return to the current date and time, press **MENU**, then highlight 'Use Current Date and Time', and press **ENTER/MARK**.

To toggle between North Up and Track Up:

1. From the Celes tab, press **MENU**, then use the **ARROW KEYPAD** to highlight 'Track Up' or 'North Up' and press **ENTER/MARK**.

Main Menu: Celestial Tab

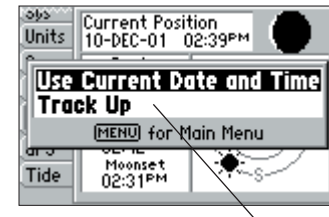
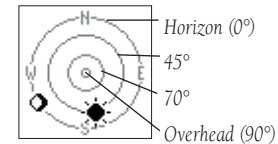
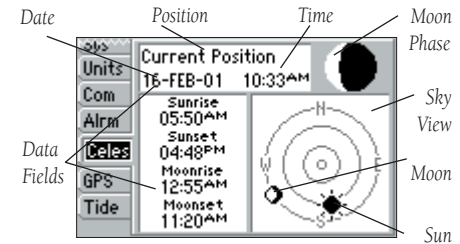

You may also change the sky view from 'North Up' to 'Track Up'.

Reference

Main Menu: GPS Tab

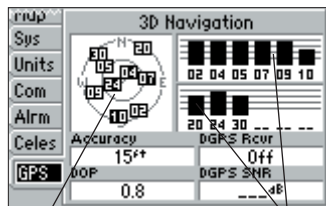

Sky View GPS tab Signal Strength Bars

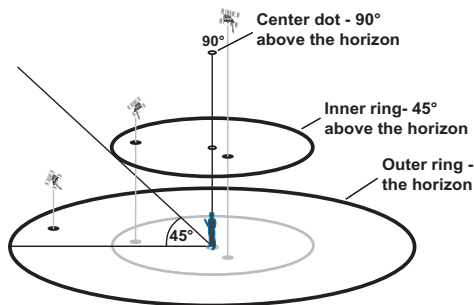

GPS Tab — Provides a visual reference of satellite acquisition, accuracy, and receiver status. The status information will give you an idea of what the receiver is doing at any given moment. The sky view and signal strength bars indicate what satellites are visible to the receiver and whether or not they are being tracked. The signal strength is shown on a bar graph for each satellite, with the satellite number below. As the receiver locks onto satellites, a signal strength bar will appear for each satellite in view, with the appropriate satellite number underneath each bar. The progress of satellite acquisition is shown in three stages:

- No signal strength bars — The receiver is looking for the satellites indicated.
- Light signal strength bars — The receiver has found the satellite(s) and is collecting data.
- Dark signal strength bars — The receiver has collected the necessary data and is ready for use.

As soon as the GPS 152 has collected the necessary data from the best satellites in view to calculate a fix, the status field will indicate a 2D or 3D status. The unit will then update the position, date and time.

You can use the sky view to help determine if any satellites are being blocked, and whether you have a current position fix (indicated by a '2D Navigation', '2D Diff Navigation', '3D Navigation', or '3D Diff Navigation' in the status field). The sky view shows a bird's-eye view of the position of each satellite relative to the receiver's last known position. The outer circle represents the horizon (north up), the inner circle 45° above the horizon, and the center point a position directly overhead (see figure to the left). You can also set the sky view to a 'Track Up' configuration, causing the top of the sky view to align along your current track heading.

WAAS Capability

The GPS 152 is capable of receiving WAAS (Wide Area Augmentation System) satellite signals. WAAS is an FAA (Federal Aviation Administration) funded project to improve the overall accuracy and integrity of the GPS signal for aviation use, but land/sea based users may also benefit from this system. At this time the system is still in the development stage and is not fully operational. There are currently two WAAS satellites that can be received in the U.S.A., one over the Atlantic Ocean and one over the Pacific Ocean, in a geo-stationary orbit over the equator. Effective use of the WAAS satellite signal may be limited by your geographic location in relation to those satellites, now in developmental service.

WAAS satellite signal reception requires an absolutely clear view of the sky and works best when there are no nearby obstructions such as buildings, mountains, etc. WAAS satellites will be numbered 33 or higher when viewing the sky view on your GPS 152. Initial reception of the WAAS signal may take up to 15-20 minutes, then 1-2 minutes afterwards. When WAAS differential correction has been received for GPS satellites (numbers 32 or below), a 'D' will appear in the signal bar of the sky view and '2D or 3D Diff Navigation' will appear in the receiver status. To learn more about the WAAS system, its satellite positions and current state of development, visit the FAA web site (<http://gps.faa.gov>). Since WAAS requires CPU resources of the GPS 152 to search for and track the satellites, you may disable the WAAS feature to improve unit performance if WAAS reception is not available in your area.

To Disable/Enable WAAS capability:

1. From the GPS tab, press **MENU**, then use the **ARROW KEYPAD** to highlight 'Disable WAAS' or 'Enable WAAS' and press **ENTER/MARK**.

Receiver Status, Accuracy and DOP

Receiver status is indicated at the top field of the page, with the current Accuracy and Dilution Of Precision (DOP) below the sky view. DOP is an indication of satellite geometry quality measured on a scale of one to ten (lowest numbers the best, highest numbers the poorest). Accuracy uses DOP and other factors to calculate horizontal position accuracy in feet or meters. The status field will show one of the following conditions:

- Looking For Satellites — The receiver is looking for any satellites.
- AutoLocate— The receiver is looking for any satellite whose almanac has been collected. This process can take up to five minutes.
- Acquiring Satellites — The receiver is looking for and collecting data from satellites visible at its last known or initialized position, but has not collected enough data to calculate a fix.
- 2D Navigation — At least three satellites with good geometry have been acquired and a two-dimensional position fix (latitude and longitude) is being calculated. '2D Differential Navigation' will appear when you are receiving DGPS or WAAS corrections in 2D mode and a 'D' will show on the strength bar of satellites being corrected.

Reference

Main Menu: GPS Tab



GPS Tab Menu Options

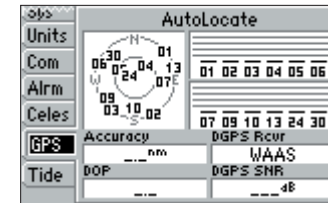

Autolocate Mode

Reference

Main Menu: GPS Tab

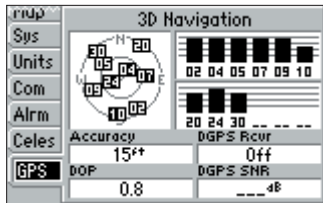
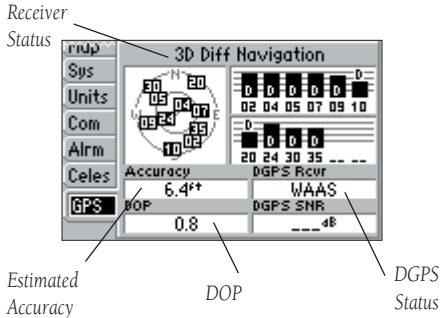

GPS Tab With WAAS Disabled

- 3D Navigation — At least four satellites with good geometry have been acquired and your position is now being calculated in latitude, longitude and altitude. '3D Differential Navigation' will appear when you are receiving DGPS or WAAS corrections in 3D mode and a 'D' will show on the strength bar of satellites being corrected.
- Poor GPS Coverage — The receiver is no longer tracking enough satellites for a 2D or 3D fix.
- Receiver Not Usable — The receiver is unusable, possibly due to interference or abnormal satellite conditions. Turn the unit off and back on to reset.
- Simulating Navigation — The receiver is in simulator mode.

The 'DGPS Rcvr' and 'Diff SNR' fields appear below the 'Accuracy' and 'DOP' fields. The Differential Receiver status field will show one of the following:

- Off — No optional beacon receiver attached or enabled in the Com menu.
- WAAS — WAAS capability enabled.
- No Signal — DGPS receiver attached, but not transmitting RTCM data to GPS.
- Tuning — Receiver is tuning manual frequency.
- Scanning — DGPS receiver is scanning for available frequency.
- Rcvng — Unit is receiving DGPS corrections.
- Chk Wiring — DGPS is enabled in Com menu, but no DGPS receiver attached or bad corrections.

The Differential SNR (Signal to Noise Ratio) indicates, on a scale to 0-30db with 30db being the best, the strength of the DGPS signal being received. If no optional DGPS receiver is used with the GPS 152, the 'DGPS Rcvr' field will display 'Off' and the 'DGPS SNR' field will be blank. The SNR will depend upon the mounting of your DGPS receiver and the distance from the DGPS transmitting station.

The GPS 152's GPS Tab features an options page that provides access to functions and features relating to the GPS Tab.

To display the GPS Tab options:

1. Press **MENU**.

To select a menu option:

1. Using the **ARROW KEYPAD**, highlight the desired option and press **ENTER/MARK**.

The following menu options are available on the GPS Tab:

- Start/Stop Simulator — Allows you to enable/disable the Simulator mode.
- Enable/Disable WAAS — Toggles the WAAS capability of the receiver on or off.
- Track Up/North Up — Allows you to select between a north up or track up sky view display (for the GPS tab only).
- AutoLocate — Allows the receiver to locate your position automatically. This process can take up to five minutes.
- Initialize Position — Allows you to initialize the receiver graphically on the Map Page to initially help the receiver acquire more quickly. See pages 4-5 for instructions on initialization.
- Set 2D Altitude — Allows you to manually enter the altitude when in 2D Navigation or Simulator mode only. Any altitude entered will be automatically calculated when the GPS is in 3D Navigation mode.

Main Menu: GPS Tab



GPS Tab Menu Options

Reference

Main Menu: Tide Tab

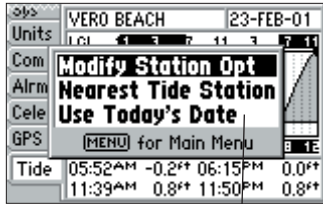

Tide Tab Menu Options



You can select from a list of nearest stations or from the map.

Tide Tab— shows a graphical chart which displays tide station information in a 24 hour span starting at midnight station time. You can choose from different dates and over 3000 tide stations around the USA coastline, Alaska, Hawaii, western Canada and several of the Caribbean islands.

The top of the page displays the tide station being referenced, to the right, the date. The top of the chart shows a 24-hour block of local time (LCL) for your position, with the reported station time (STA) appearing at the bottom. Daylight (light bar) and nighttime (dark bar) show across the time scale, with the time progressing from left to right (Local time scales may not be available for a few stations). The solid, light vertical lines are in 4-hour increments, and the light, dotted vertical lines are in 1-hour increments. A dark, vertical line (with arrows at the ends of the line) will indicate the time of day when using the current date and will intersect the tide graph to show their relation.

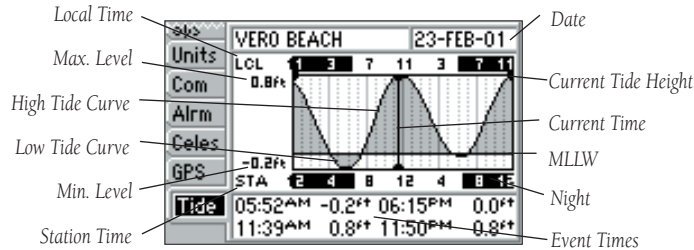

The tide curve shows as a shaded area, with higher tides being taller and lower tides shorter. The dark, horizontal line (with arrows at the ends of the line) indicates the current tide height. The figure to the left of the line will show the current tide level in feet. The Mean Lower Low Water (MLLW) appears as a solid, horizontal line near the bottom of the chart (This line will only appear if the tide ranges to the zero value or below). The numbers directly below/above 'LCL' and 'STA' indicate the maximum/minimum levels, respectively. The four data fields below the chart, indicate event times and levels at which the tide changes starting in the upper left field, going downward, then to the upper right and down again.

To select the nearest tide station from you current location:

1. From the "Tide" tab, press **MENU**, then using the **ARROW KEYPAD**, highlight 'Nearest Tide Station' and press **ENTER/MARK**.

The name of the closest station will appear in the 'For' field. You must be within 100 miles of a 'tide station' to use the 'Nearest Tide Station' option. If you are not within this range, you will see a message "No Tide Stations For That Area." Use the 'Select From Map' option and select a location closer to a tide station.

To select a tide station from the map:

1. From the Tide tab, press **MENU**, then using the **ARROW KEYPAD**, highlight 'Modify Station Opt' and press **ENTER/MARK**. Highlight the 'Tide Station' field and press **ENTER/MARK**.
2. Highlight 'Select From Map' from the bottom of the list and press **ENTER/MARK**.
3. Select a position on the map and press **ENTER/MARK**.
4. A list will appear showing up to nine of the nearest tide stations. Highlight the desired station and press **ENTER/MARK**. If the "No Tide Stations For That Area" message appears, repeat steps 1-4 until you find a station.

You may also change the date to view tide charts for another date.

To change the date for the tide chart:

1. From the Tide tab, press **MENU**, then using the **ARROW KEYPAD**, highlight 'Modify Station Opt' and press **ENTER/MARK**.
2. Highlight the 'Date' field, press **ENTER/MARK**, and enter the desired date and press **ENTER/MARK**.

To use the current date:

1. Press **MENU**, then highlight 'Use Today's Date' and press **ENTER/MARK**.

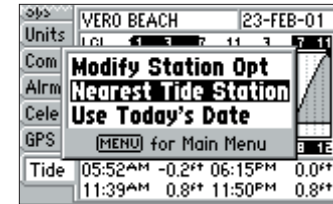
**Main Menu:
Tide Tab**

You may automatically search for the nearest station and also view past and future tide information.

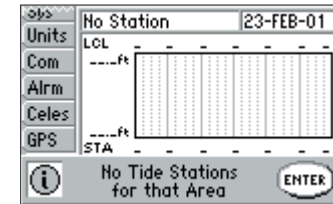

You must select a location within 100 nm of a tide station.



If MapSource POIs or other MapSource products are loaded into the unit, the tides, cities and marine nav aids will be deleted from the system. Check the GARMIN web site (www.garmin.com) for updates to reinstall the original factory-loaded data.

Appendix A

Loran TD



You may change to Loran TD from either the Map Page or Units Tab on the Main Menu.

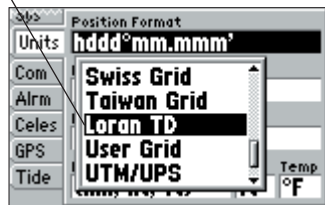

Loran TD System

LORAN C is a radio navigation aid operated and maintained in the United States by the United States Coast Guard. The name LORAN is an acronym for “LONG RANGE Navigation.” The LORAN system covers the entire United States and the U.S. Coastal Confluence Zone. From the perspective of a mariner, the system is used for ocean and coastal navigation. It can be used as a supplemental system for harbor and harbor approach navigation, and it is used for inland navigation by recreational vehicles.

LORAN TD Feature

The LORAN TD (Time Delay) feature eases the transition from using LORAN to using GPS. The GPS unit automatically converts GPS coordinates to LORAN TDs for those who have a collection of LORAN fixes for favorite fishing spots and other waypoints recorded as TDs. You can display your position as a TD or enter waypoints as TDs. The accuracy to be expected from this conversion is approximately 30 meters. When the unit is placed in the LORAN TD format mode, it simulates the operation of a LORAN receiver. Position coordinates may be displayed as TDs, and all navigation functions may be used as if the unit was actually receiving LORAN signals.

Using the LORAN TD Format

When creating new waypoints using LORAN TD coordinates, you must set the correct LORAN chain number and secondary stations in the Setup TD field before storing the waypoint. After the waypoint is stored in unit memory, it will always reference the LORAN chain number and secondary stations currently selected in the Setup TD field. If you enter a different LORAN chain number, change the secondary stations or offsets in the Setup TD field, the active waypoint information will reflect those changes. Since the GPS unit does not rely on the LORAN signal for navigation, it can reference a different GRI chain and/or secondary stations and still navigate to the location stored in memory.

The LORAN Position Format field is located under the Units tab in the Main Menu. The 'LORAN TD Setup' window contains the fields to select the Loran GRI Chain Number, Primary and Secondary Stations, and TD Offsets.

To set up Loran TD from the Main Menu:

1. Using the **ARROW KEYPAD**, highlight the "Units" tab and then the "Position Format" field press **ENTER/MARK**.
2. Highlight 'Loran TD', press **ENTER/MARK**, then highlight 'Setup' and press **ENTER/MARK**.
3. To change the settings of any of the five fields, highlight the field, press **ENTER/MARK**, enter the desired setting and press **ENTER/MARK**.
4. When done, press the **QUIT** key to return to the Main Menu.

To setup Loran TD from the Map Page:

1. Press **MENU**, then use the **ARROW KEYPAD** to highlight 'Loran TD On' and press **ENTER/MARK**.
2. To change the settings of any of the five fields, highlight the field, press **ENTER/MARK**, select/enter the desired setting and press **ENTER/MARK**.
3. When done, press the **QUIT** key to return to the Map Page.

If the active GRI Chain, secondary stations or offsets have been changed since the waypoint was created, the waypoint will now reference the active GRI chain and secondary stations and adjust the TD coordinates accordingly. Remember that the GPS is not relying on the LORAN signal for navigation and actually converts the TD coordinate to a useful LAT/LON coordinate (in the background) before storing the waypoint to memory or using it for navigation. Because of this, the unit can navigate to a TD coordinate anywhere in the world.

Loran TD Setup

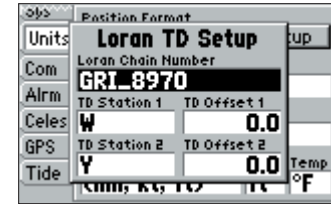

Loran TD Setup Page

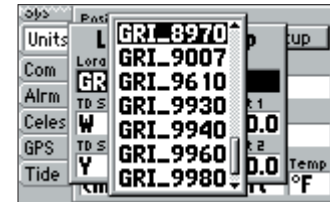

Selecting the Loran Chain Number

Appendix B

Time Offsets



A simple way to determine your local time offset is how many hours you are behind or ahead of UTC (also called 'Greenwich' or 'zulu' time).

Example: EST (Eastern Standard Time) is 5 hours behind UTC, so your offset would be -5. Adding one hour for daylight savings would make EDT (Eastern Daylight Time) - 4. Subtract an hour for each time zone as you travel west.

Offsets for Continental U.S. would be:

EST	-5	EDT	-4
CST	-6	CDT	-5
MST	-7	MDT	-6
PST	-8	PDT	-7

The chart below gives an approximate UTC (Universal Time Coordinate) time offset for the various longitudinal zones. Check with local charts for more detailed information. If you are in daylight savings time, add one hour to the offset.

Longitudinal Zone	Offset	Longitudinal Zone	Offset
W180.0° to W172.5°	-12	E007.5° to E022.5°	+1
W172.5° to W157.5°	-11	E022.5° to E037.5°	+2
W157.5° to W142.5°	-10	E037.5° to E052.5°	+3
W142.5° to W127.5°	-9	E052.5° to E067.5°	+4
W127.5° to W112.5°	-8	E067.5° to E082.5°	+5
W112.5° to W097.5°	-7	E082.5° to E097.5°	+6
W097.5° to W082.5°	-6	E097.5° to E112.5°	+7
W082.5° to W067.5°	-5	E112.5° to E127.5°	+8
W067.5° to W052.5°	-4	E127.5° to E142.5°	+9
W052.5° to W037.5°	-3	E142.5° to E157.5°	+10
W037.5° to W022.5°	-2	E157.5° to E172.5°	+11
W022.5° to W007.5°	-1	E172.5° to E180.0°	+12
W007.5° to E007.5°	0		

Messages

The GPS 152 uses an on-screen pop-up message system to alert you to unit operating characteristics. Press the **ENTER** key to acknowledge and return to the page you were viewing.

Alarm Clock— The alarm clock has sounded.

Anchor Drag Alarm— You have drifted out of the specified distance range.

Antenna Input Shorted To Ground— Check antenna wiring/connections or antenna replacement.

Approaching Waypoint— You are a specified alarm distance from a destination waypoint.

Arrival At Waypoint— You have arrived at the destination waypoint.

Basemap Failed Unit Needs Repair— Internal problem with unit. Contact your dealer or GARMIN Customer Service (page i) to have the unit serviced.

Database Error— Internal problem with unit. Contact your dealer or GARMIN Customer Service (page i) to have the unit serviced.

Lost Satellite Reception— The unit has lost satellite signals. Check antenna connections or try moving to a location with a clear view of the sky.

Memory (RAM) Failed Unit Needs Repair— Internal problem with unit. Contact your dealer or GARMIN Customer Service (page i) to have the unit serviced.

Memory (ROM) Failed Unit Needs Repair— Internal problem with unit. Contact your dealer or GARMIN Customer Service (page i) to have the unit serviced.

No DGPS Position— No differential correction data is available or not enough data is available to compute a DGPS position.

No Tide Stations For That Area— No tide stations within 100 miles of the specified point. Try another area.

Off Course Alarm— You have exceeded the specified off-course distance.

Processor Failed Unit Needs Repair— Internal problem with unit. Contact your dealer or GARMIN Customer Service (page i) to have the unit serviced.

Proximity Alarm List is Full— You have used all ten proximity waypoints.

Appendix C

Messages

Proximity Alarm Waypoint— You have entered the alarm radius for the proximity waypoint indicated.

Proximity Overlaps Another Proximity Waypoint—The alarm radius specified overlaps the area specified for another proximity waypoint. Adjust distance.

Route Already Exists: <route name>— You have entered a route name that already exists in memory. Modify the route name or delete the previous route name.

Route Does Not Exist: <route name>— Route has been renamed or removed from memory and cannot be used.

Route Is Full— You have attempted to add more than 30 points to a route. Reduce number of points or create second route.

Route Memory Is Full Can't Create Route— Maximum amount of 20 routes already in unit memory and no additional routes can be added until existing ones are removed.

Route Truncated— Uploaded route from other device has more than 30 points. Reduce number of points.

Running Simulator— Unit is in simulator (practice) mode.

Track Already Exists: <track name>— You have entered a saved track name that already exists in memory. Modify the track name or delete the previous track name.

Track Memory Is Full Can't Create Track— Track log memory is full. No additional track log data can be stored without deleting old data to create memory space.

Track Truncated— A complete upload track will not fit into memory. The oldest track log points were deleted to make space for the most recent data.

Transfer Complete— The unit has finished uploading/downloading information to the connected device.

Waypoint Already Exists: <waypoint name>— You have entered a waypoint name that already exists in memory. Modify waypoint name or delete the previous waypoint name.

Waypoint Memory Is Full Can't Create Waypoint— You have used all 500 waypoints available. Delete unwanted waypoints to make space for new entries.

Adindan	Adindan- Ethiopia, Mali, Senegal, Sudan
Afgooye	Afgooye- Somalia
AIN EL ABD '70	AIN EL ANBD 1970- Bahrain Island, Saudi Arabia
Anna 1 Ast '65	Anna 1 Astro '65- Cocos I.
ARC 1950	ARC 1950- Botswana, Lesotho, Malawi, Swaziland, Zaire, Zambia, Zimbabwe
ARC 1960	Kenya, Tanzania
Ascnsn Isld '58	Ascension Island '58- Ascension Island
Astro B4 Sorol	Sorol Atoll- Tern Island
Astro Bcn "E"	Astro Beacon "E"- Iwo Jima
Astro Dos 71/4	Astro Dos 71/4- St. Helena
Astro Stn '52	Astronomic Stn '52- Marcus Island
Aus Geod '66	Australian Geod '66- Australia, Tasmania Island
Aus Geod '84	Australian Geod '84- Australia, Tasmania Island
Austria	Austria
Bellevue (IGN)	Efate and Erromango Islands
Bermuda 1957	Bermuda 1957- Bermuda Islands
Bogata Observ	Bogata Observatory- Colombia
Campo Inchspe	Campo Inchauspe- Argentina
Canton Ast '66	Canton Astro 1966- Phoenix Islands
Cape	Cape- South Africa
Cape Canavrl	Cape Canaveral- Florida, Bahama Islands
Carthage	Carthage- Tunisia
CH-1903	CH 1903- Switzerland
Chatham 1971	Chatham 1971- Chatham Island (New Zealand)

Chua Astro	Chua Astro- Paraguay
Corrego Alegr	Corrego Alegre- Brazil
Djakarta	Djakarta (Batavia)- Sumatra Island (Indonesia)
Dos 1968	Dos 1968- Gizo Island (New Georgia Islands)
Dutch	Dutch
Easter Isld 67	Easter Island 1967
European 1950	European 1950- Austria, Belgium, Denmark, Finland, France, Germany, Gibraltar, Greece, Italy, Luxembourg, Netherlands, Norway, Portugal, Spain, Sweden, Switzerland
European 1979	European 1979- Austria, Finland, Netherlands, Norway, Spain, Sweden, Switzerland
Finland Hayfrd	Finland Hayford- Finland
Gandajika Base	Gandajika Base- Republic of Maldives
GDA	Geocentric Datum of Australia
Geod Datm '49	Geodetic Datum '49-New Zealand
Guam 1963	Guam 1963- Guam Island
Gux 1 Astro	Guadalcanal Island
Hjorsey 1955	Hjorsey 1955- Iceland
Hong Kong '63	Hong Kong
Hu-Tzu-Shan	Taiwan
Indian Bngldsh	Indian- Bangladesh, India, Nepal
Indian Thailand	Indian- Thailand, Vietnam
Indonesia 74	Indonesia 1974-Indonesia
Ireland 1965	Ireland 1965- Ireland
ISTS 073 Astro	ISTS 073 ASTRO '69- Diego Garcia
Johnston Island	Johnston Island

Appendix D

Map Datums



The 'User' datum is based on a WGS-84-Local datum and is an advanced feature for unlisted or custom datums. Check your local library or on the world wide web for educational materials on datums and coordinate systems.

Appendix D

Map Datums

Kandawala	Kandawala- Sri Lanka
Kergueln Islnd	Kerguelen Island
Kertau 1948	West Malaysia, Singapore
L.C. 5 Astro	Cayman Brac Island
Liberia 1964	Liberia 1964- Liberia
Luzon Mindanao	Luzon- Mindanao Island
Luzon Philippine	Luzon- Philippines (excluding Mindanao Isl.)
Mahe 1971	Mahe 1971- Mahe Island
Marco Astro	Marco Astro- Salvage Isl.
Massawa	Massawa- Eritrea (Ethiopia)
Merchich	Merchich- Morocco
Midway Ast '61	Midway Astro '61- Midway
Minna	Minna- Nigeria
NAD27 Alaska	North American 1927- Alaska
NAD27 Bahamas	North American 1927- Bahamas (excluding San Salvador Island)
NAD27 Canada	North American 1927- Canada and Newfoundland
NAD27 Canal Zn	North Am. 1927- Canal Zone
NAD27 Caribbn	North American 1927- Caribbean (Barbados, Caicos Islands, Cuba, Dominican Repuplc, Grand Cayman, Jamaica, Leeward and Turks Islands)

NAD27 Central	North American 1927-Central America (Belize, Costa Rica, El Salvador, Guatemala, Honduras, Nicaragua)
NAD27 CONUS	North Am. 1927- Mean Value (CONUS)
NAD27 Cuba	North American 1927- Cuba
NAD27 Grnland	North American 1927- Greenland (Hayes Peninsula)
NAD27 Mexico	N. American 1927- Mexico
NAD27 San Sal	North American 1927- San Salvador Island
NAD83	North American 1983- Alaska, Canada, Central America, CONUS, Mexico
Naparima BWI	Naparima BWI- Trinidad and Tobago
Nhrwn Masirah	Nahrwn- Masirah Island (Oman)
Nhrwn Saudi A	Nahrwn- Saudi Arabia
Nhrwn United A	Nahrwn- United Arab Emirates
Obsrvtorio '66	Observatorio 1966- Corvo and Flores Islands (Azores)
Old Egyptian	Old Egyptian- Egypt
Old Hawaiian	Old Hawaiian- Mean Value
Oman	Oman- Oman
Ord Srvy GB	Old Survey Great Britain- England, Isle of Man, Scotland, Shetland Isl., Wales
Pico De Las Nv	Canary Islands
Potsdam	Potsdam-Germany
Prov S Am '56	Prov So Amrcn '56- Bolivia, Chile, Colombia, Ecuador, Guyana, Peru, Venezuela
Prov S Chln '63	So Chilean '63- S. Chile
Ptcairn Ast '67	Pitcairn Astro '67- Pitcairn
Puerto Rico	Puerto Rico & Virgin Isl.
Qatar National	Qatar

Qornoq	Qornoq- South Greenland
Reunion	Reunion- Mascarene Island
Rome 1940	Rome 1940- Sardinia Isl.
RT 90	Sweden
Santo (Dos)	Santo (Dos)- Espirito Santo
Sao Braz	Sao Braz- Sao Miguel, Santa Maria Islands
Sapper Hill '43	Sapper Hill 1943- East Falkland Island
Schwarzeck	Schwarzeck- Namibia
SE Base	Southeast Base- Porto Santo and Madiera Islands
Sth Amrcn '69	South American '69- Argentina, Bolivia, Brazil, Chile, Colombia, Ecuador, Guyana, Paraguay, Peru, Venezuela, Trinidad/Tobago
South Asia	South Asia- Singapore
SW Base	Southwest Base- Faial, Graciosa, Pico, Sao Jorge and Terceira Islands
Taiwan	Taiwan
Timbalai 1948	Timbalai 1948- Brunei and E. Malaysia (Sarawak and Sabah)
Tokyo	Tokyo- Japan, Korea, Okinawa
Tristan Ast '68	Tristan Astro 1968- Tristan da Cunha
Viti Levu 1916	Viti Levu 1916- Viti Levu/Fiji Islands
Wake-Eniwetok	Wake-Eniwetok- Marshall
WGS 72	World Geodetic System 72
WGS 84	World Geodetic System 84
Zanderij	Zanderij- Surinam
User	User-defined custom datum

Navigation Terms

Altitude— Height above mean sea level (MSL).

Avg Speed— The average of all second-by-second speed readings since last reset.

Bearing (BRG)— The compass direction from your present position to a destination waypoint.

Course— The desired course between the active 'from' and 'to' waypoints.

Distance (Dist)— The 'great circle' distance from present position to a destination waypoint.

Dist to Dest— The 'great circle' distance from present position to a GOTO destination, or the final waypoint in a route.

Dist to Next— The 'great circle' distance from present position to a GOTO destination, or the next waypoint in a route.

ETA— Estimate Time of Arrival. The estimated time you will reach your destination waypoint, based on current speed and track.

ETA at Dest— The estimated time you will reach a GOTO destination, or the final waypoint in a route.

ETA at Next— The estimated time you will reach a GOTO destination, or the next waypoint in a route.

Fuel— The fuel required to travel from present position to the indicated route waypoint.

Leg Dist— The distance between two route waypoints.

Leg Fuel— The fuel required to travel from a route waypoint to the next waypoint (in sequence) in the route.

Leg Time— The time required to travel from a route waypoint to the next waypoint (in sequence) in the route.

Max Speed— The maximum second-by-second speed recorded since last reset.

Moving Average Speed— Average speed while the unit is moving.

Moving Trip Timer— Total time the unit has been moving.

Appendix E

Navigation Terms

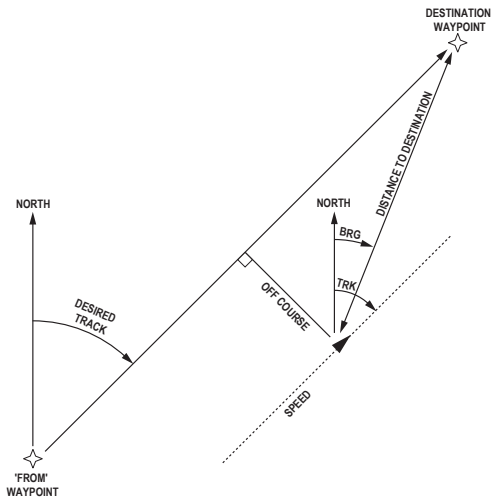

Odometer— A running tally of distance travelled, based upon the distance between second-by-second position readings.

Off Course— The distance you are off a desired course in either direction, left or right. Also referred to as ‘cross-track error’ or ‘course error’.

Speed— The current velocity at which you are travelling, relative to a ground position. Also referred to as ‘ground speed’.

Time To— The estimated time required to reach a GOTO destination, or the next waypoint in a route. Also referred to as ‘estimated time en route’.

Time to Dest— The estimated time required to reach a GOTO destination, or the final waypoint in a route.

Time to Next— The estimated time required to reach a GOTO destination, or the next waypoint in a route.

To Course— The recommended direction to steer in order to reduce course error or stay on course. Provides the most efficient heading to get back to the desired course and proceed along your route.

Track— The direction of movement relative to a ground position. Also referred to as ‘ground track’.

Trip Odometer— A running tally of distance travelled since last reset. Also see ‘Odometer’.

Total Average Speed— Average speed of unit for both moving and stopped speeds since last timer reset.

Total Trip Timer— Total time the unit has been in operation since last reset of the trip timers.

Turn— The angle difference between the bearing to your destination and your current track. ‘L’ indicates you should turn left, ‘R’ indicates you should turn right. The degrees indicate the angle you are off course.

VMG— Velocity Made Good. The speed you are closing in on a destination along a desired course. Also referred to as the ‘vector velocity’ to your destination.

Specifications

Physical Specifications

Size:	5.0" W x 4.9" H x 2.5" D (13.4 x 12.5 x 6.1 cm)
Weight:	Less than 1 pound (454 g)
Display:	4.0" diagonal (10.2 cm) high-contrast, 4-level gray FSTN with adjustable backlighting (160 x 100 pixels)
Case:	Fully gasketed, high-impact plastic alloy, waterproof to IEC 529-IPX-7
Temp. Range:	5°F to 158°F (-15°C to 70°C)

Performance

Receiver:	Differential-ready 12 parallel channel WAAS capable receiver
Acquisition Times:	
Warm:	Approx. 15 seconds
Cold:	Approx. 45 seconds
AutoLocate:	Approx. 2 minutes
Update Rate:	1/second, continuous
GPS Accuracy:	Position*: <15 meters (49 feet), 95% typical* Velocity: 0.05 meters/sec steady state
DGPS (USCG) Accuracy:	Position: 3-5 meters (10-16 feet) with optional GARMIN DGPS receiver, 95% typical* Velocity: 0.05 meters/sec steady state
DGPS (WAAS) Accuracy:	Position: <3 meters (10 feet), 95% typical* Velocity: 0.05 meters/sec steady state
Dynamics:	6g's

* Subject to accuracy degradation to 100m 2DRMS under the U.S. DOD-imposed Selective Availability Program.

Power

Source:	10-40V DC
Usage:	5 watts max. @10VDC
Fuse:	AGC/3AG - 1.5 Amp

Appendix G

Antenna Installation

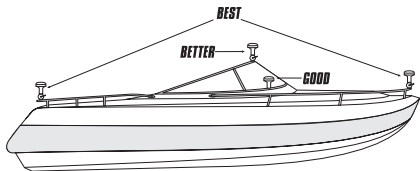

Suggested locations for mounting the GA 29 antenna.



It is possible to route the coaxial cable either through or outside the antenna mount. The BNC connector on the coaxial cable can be removed, and the coaxial cable shortened to ease installation. If the BNC connector is removed it must be replaced with a new BNC connector.

Installing the GPS 152

The GPS 152 must be properly installed according to the following instructions to get the best possible performance. If you have the GPS 152 with the built-in internal bail mount antenna, you may skip this section and proceed to the next page. For units purchased with the external GA 29 antenna, follow the instructions below. To complete the installation, you'll need the appropriate fasteners and a 1" x 14-thread marine antenna mount available at most marine dealers.

Mounting the GPS Antenna

The antenna should be mounted in a location that has a clear, unobstructed view of the sky in all directions and as far away from interference as possible to ensure the best reception. Avoid mounting the antenna where it will be shaded by the boat's superstructure, a radome antenna, or mast. Sailboat users should avoid mounting the antenna high on the mast to prevent inaccurate speed readings caused by excessive heeling. Most marine VHF and LORAN antennas should not seriously degrade the GPS antenna's reception. It is a good idea to temporarily place the antenna and unit in the desired mounting location and test any other nearby electronics to see if they interfere with the GPS unit. Never paint the antenna or clean it with harsh solvents.

The GARMIN antenna screws directly onto any standard 1" x 14-thread antenna mount. If you need to raise the antenna to avoid shading, try using a 1" x 14-thread extension mast available at most marine dealers.

To install the GPS antenna:

1. Screw the antenna directly onto the 1" x 14-thread mount.
2. Route the cable to the mounting location of the display unit. Use the appropriate tie-wraps, fasteners and sealant to secure the cable along the route and through any bulkhead or deck.
3. Once the GPS 152 unit has been installed, connect the cable to the antenna connector on the back of the display unit. Make sure that you turn the antenna cable connector 1/4 turn clockwise to lock the cable into place.

Mounting the GPS 152 Unit

The GPS 152's compact, waterproof case is suitable for mounting in exposed locations or at the navigation station. The unit comes with a gimbal bracket and may be surface mounted or flush mounted. When choosing a location for the display unit, make sure you consider the following conditions:

- There should be at least a 3" (5 cm) clearance behind the case to allow connection of the antenna (external antenna only), power/data cables.
- The mounting surface should be heavy enough to support the unit and protect it from excessive vibration and shock.
- For units with the built-in internal bail mount antenna, it should be mounted in a location that has the clearest, most unobstructed view of the sky in all directions to ensure the best reception. Avoid mounting the unit where it will be blocked by the boat's superstructure, a radar arch, or mast.



The temperature range for the GPS 152 is 5°F to 158°F (-15°C to 70°C). Extended exposure to temperatures exceeding this range (in storage or operating conditions) may cause failure of the LCD screen. This type of failure and related consequences are NOT covered by the manufacturer's limited warranty.

To surface mount the GPS 152 unit:

1. Place the mounting bracket in the desired location.
2. Mark and drill the four mounting holes for the fastener you are using.
3. Fasten the bracket to the surface using the appropriate fastener.
4. Insert the GPS 152 into the mounting bracket. The bracket is designed for a tight fit to provide additional support when swiveling the unit.
5. Screw the two mounting knobs through the bracket and into the display case.
6. Connect the power/data and antenna cables (external antenna only) to the back of the unit, making sure the locking rings are fully tightened on both connectors.

Unit Installation

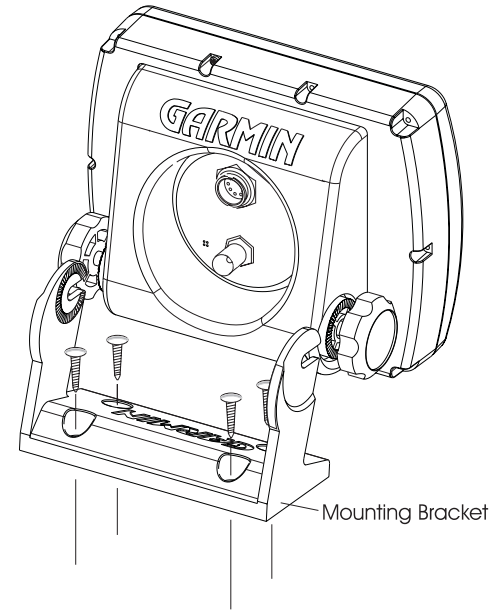

Appendix G

Unit Installation

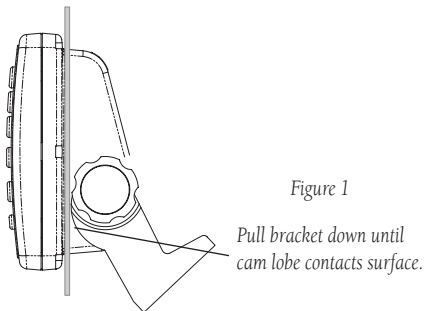

Figure 2

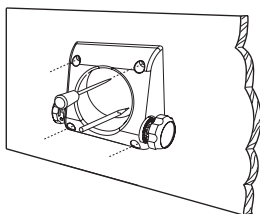
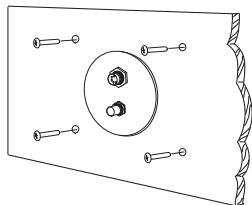

Figure 3



The GPS 152 with external antenna can be flush mounted on a flat panel of .08-.52" thickness using the cam lobe feature on its mounting bracket

To flush mount the GPS 152 unit:

1. Cut a 4.25"W x 4.25"H (108 x 108 mm) hole in the panel.
2. Place the GPS 152 into the hole from the front until the flange rests against the mounting surface.
3. From the back of the panel, loosely attach the bracket such that the slot in the ratchet area points away from the mounting panel.
4. Rotate the bracket downward until the panel is pinched tightly between the unit's flange and bracket lobe (figure 1).
5. Tighten the knobs and connect the power/data and antenna cables. Note: if the panel is too thick to allow use of the supplied knobs, two M6 screws may be used to secure the bracket.

The International version of the GPS 152, with external antenna, can be flush mounted on a flat panel with its existing mounting bracket.

To flush mount the International version GPS 152 unit:

1. Remove the four M5 screws from the back of the unit and remove the mounting bracket.
2. Using the mounting bracket as a template, outline the center relief hole and mark the location of the four screw holes centers on your bulkhead or other surface (figure 2).
3. Cut the 2.75" (70 mm) relief hole from the panel and drill the four 0.20" (5.08 mm) screw holes.
4. From the front, place the GPS 152 into the relief hole until it rests flush against the mounting surface.
5. Secure the unit to the mounting surface using the M5 screws. For thick mounting surfaces, insert the M5 screws directly through the drilled holes (figure 3). For thin panels, place the mounting bracket on the back side of the panel for more support. Connect the power/data and antenna cables.

Connecting the Power/Data

The power/data cable connects the GPS 152 to a 10-40 volt DC system and provides interface capabilities for connecting external devices. The color code in the diagram below indicates the appropriate harness connections. The replacement fuse is an AGC/3AG - 1.5 Amp fuse.

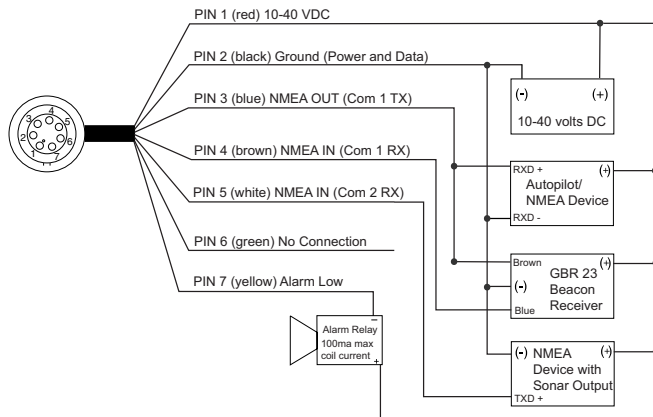

Interfacing

The following formats are supported for connection of external devices: GARMIN proprietary Differential GPS (DGPS), NMEA 0183 (version 2.3), RTCM SC-104 input (version 2.0).

The following are the sentences for NMEA 0183, version 2.3 output: Approved sentences — GPBOD, GPBWC, GPGGA, GPGLL, GPGSA, GPGSV, GPRMB, GPRMC, GPRTE, GPVTG, GPWPL, and GPXTE; Proprietary sentences — PGRME, PGRMM, PGRMZ, and PSLIB. The GPS 152 also includes NMEA input with support for the WPL sentence and sonar NMEA input with support for the DBT (Depth Below Transducer), DPT (Depth), MTW (Water Temp) and VHW (Water Speed & Heading) sentences. If connecting to COM2 for sonar NMEA input, the unit interface must be set to GARMIN DGPS, Other DGPS (4800 only), or NMEA In/NMEA Out (see page 60). If connecting to COM1, the unit must be set to NMEA In/NMEA Out.

Appendix G

Wiring and Interfacing

You can download a copy of GARMIN's proprietary communication protocol the Help and Support section of our web site at www.garmin.com.

Complete information concerning NMEA & RTCM formats and sentences is available for purchase from NMEA at:

NMEA
7 Riggs Avenue
Severna Park, MD 21146
U.S.A.
410-975-9425
410-975-9450 FAX
www.nmea.org

Radio Technical Commission For
Maritime Services (RTCM)
1800 Diagonal Road, Suite 600
Alexandria, VA 22314-2480
U.S.A.
703-684-4481 (Info Only)
703-836-4229 FAX
www.rtcn.org

Appendix H

Advanced NMEA Setup

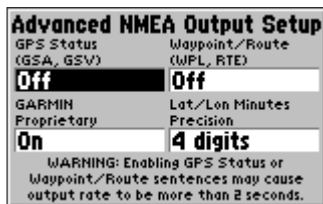

Advanced NMEA Setup Page

NMEA Interface

If you are going to interface the GPS 152 with another piece of equipment (such as a radar or autopilot), the unit needs to be set to output NMEA data. The NMEA data can be customized to shorten the update time from the unit. If too many NMEA sentences are activated, the unit may take longer than two seconds to update.

To activate the NMEA data:

1. With the GPS 152 turned on, press **MENU** twice to display the Main Menu. Use the **ARROW KEYPAD** to select the Com tab.
2. Highlight the 'Serial Data Format' field and press **ENTER/MARK**.
3. Select 'NMEA In/NMEA Out' and press **ENTER/MARK**.

Advanced NMEA Output Setup

The GPS 152 NMEA data transmission can be customized to keep the output rate at two seconds. If the unit is set up to output all of the available NMEA sentences, the output rate may exceed two seconds. The 'Advanced NMEA Output Setup' page will allow you to turn on/off the GPS Status (GSA, GSV), Waypoint/Route (WPL, RTE) and the GARMIN Proprietary sentences. You can also change the precision of the Lat/Lon minutes.

To set up the Advanced NMEA Output:

1. With 'NMEA In/NMEA Out' selected, press **MENU**. Select 'NMEA Setup' and press **ENTER/MARK**.
2. To turn a field On/Off, place the highlight over the desired field and press **ENTER**. Make a selection and press **ENTER** again to accept the selection.

GPS 152 NMEA Sentence Output (NMEA Version 2.3 compliant)

Always transmitted: GPRMC, GPGG, GPGL, GPBWC, GPVTG, GPXTE, GPRMB

Switchable sentences: GPGSA, GPGSV, GPWPL, GPRTE

GARMIN proprietary: PGRME, PGRMZ, PGRMM

Appendix I

Index

A		
Accessories	vi	
Accuracy	65-66	
Accuracy Circle	25	
Active Route Page	15, 29, 52	
Active Track Log	54-55	
Advanced NMEA Setup	84	
Alarms	62	
Anchor Drag Alarm	62	
Arrival Alarm	62	
ARROW KEYPAD	1, 3	
AutoLocate	65	
B		
Backlighting	7	
Bearing Line	24	
Bearing/Distance Measuring	22	
Beeper	57	
C		
Capabilities	v	
Cautions	iii	
Celestial Page Setup	63	
Changing Data Fields	16, 22-23	
Clearing the Track Log	17, 41, 55	
Clock Alarm	62	
Communication Setup	60-62	
Compass Page	14, 26	
Compass Page Options	27	
Configuring the Map	24-26	
Contrast Setting	6	
Course Line	25	
Cursor Movement	9, 18-19	
Customer Service	i	
D		
Data Entry	3	
Data Fields	22-23	
Data Transfer	60	
Date/Time	56	
Daylight Savings Time	56	
Deep Water Alarm	62	
Depth Units	59	
DGPS Interfacing	60-62, 66	
Differential Receiver Status	61	
Dilution Of Precision (DOP)	65	
Distance Measurement	22	
Distance/Speed/Altitude Units	59	
E		
Editing Waypoints	33-38	
ENTER/MARK Key	1	
Entering Data	3	
F		
FCC Compliance	ii	
Follow Track	41-42	
Follow Route	12, 46	
Fuel Flow	51	
Full Screen Map	21	
G		
Go To Waypoint	39, 40	
Going to a Destination	11, 39-43	
GPS Status	64-67	
H		
Heading	59	
Heading Line	25	
Highway Page	14-15, 27-28	
“How To” Index	viii	
I		
IN Key	1	
Information Page	19, 20	
Initialization	4-5, 65-66	

Appendix I

Index

I

Installation	80-83
Interface Formats	60
Interfacing	60-62, 83, 84

K

Keypad Usage	1
--------------------	---

L

Language Selection	57
Limited Warranty	iv
Loran TD	22, 70
Loran TD Setup	71

M

Main Menu	16, 53-69
Main Pages	8
Magnetic Variation	59
Map Configuration	24-26
Map Datums	58, 75-75

Map Page	8-9, 18-26
Detail	25
Options	21-26
Orientation	25
Scales	20
Zooming	9, 20
Measuring Distance/Bearing	22
MENU Key	1
Messages	73-74
MOB	43
Moonrise/Moonset	63

N

NAV/MOB Key	1, 11
Navigation Pages	14
Navigation Terms	77-78
Nearest Tide Station	69
Nearest Waypoints List	36-37
NMEA Output Formats	60, 83, 84
Numbers Page	15, 29

O

Odometers, Trip	56
Off Course Alarm	62
OUT Key	1

P

Packing List	vi
--------------------	----

PAGE Key	1
Pages Menu	56
Position Format	58
Power Off	17
Power On	4, 6
Power/Backlight/Contrast Key	1
Preface	i
Proximity Waypoints	37-38

Q

QUIT Key	1
----------------	---

R

Receiver Status	64-67
Re-evaluate Active Route	52
Registration	i
Restore GARMIN Setup	57
Reviewing Waypoints	13, 19, 33-38
Reviewing Map Items	19
Route List Page	46-47
Route Review Page	47-51
Routes	44-52
Activating/Following	12, 43
Copying	46
Creating	44-45
Deactivating	46
Deleting	46-47, 51
Editing	46-51

Index

Inserting/Adding Points	49-50
Inverting/Reversing	51
Naming	47
Planning	51
Removing Points	48, 49, 50-51
Reviewing Points	48, 49
Trip Planning Data Fields	47
S	
Satellite Sky View	5, 64
Saved Tracks	54-55
Selecting Options and Functions	2
Serial Data Format	60
Serial Number	iv
Shallow Water Alarm	62
Signal Strength Bars	5, 64-66
Simulator	7, 57, 67
Sky View Orientation	67
Software License Agreement	iii
Software Version	57
Specifications	79
Speed (Simulated)	12
Speed Units	59
Speed Filter	57
Stop Navigation	39, 40, 42, 43
Sunrise/Sunset	63
System Setup	57

T	
Table of Contents	vii
Temperature Units	59
Tide Charts	68-69
Tide Page Settings	68-69
Time Setup	56
Time Offsets	72
Time Zone	56
TracBack	41-42, 55
Track Log	17, 41, 54-55
Clearing	17, 41, 55
Saving	41, 55
Track Setup	54-55
Tracks	54-55
Deleting	55
Displaying	28, 55
Recording	54
Trip and Fuel Planning	47, 51
Trip Timers	56
U	
Units of Measure	58-59
User Map Datum	75-76
W	
WAAS Capability	64-65
Warnings	iii
Warranty	iv

Waypoint Edit Page	33-34
Waypoint Lists	34-38
Waypoint Review Page	33-34
Waypoints	10, 13, 19, 20, 30-38
Creating	10, 13, 20, 30-32
Deleting	34, 36
Editing	33-38
Listed by Name	35-36
Moving	34
Naming	10, 33
Nearest	36-37
Proximity	37-38
Reviewing	13, 19, 33-38
Symbols	10, 13, 33-36
Wiring Installation	86
Z	
Zooming	9, 12, 15, 20, 27

**For the latest free software updates throughout the life of your GARMIN products,
visit the GARMIN web site at www.garmin.com.**



© Copyright 2001-2002
GARMIN Ltd. or its subsidiaries

GARMIN International, Inc.
1200 East 151st Street, Olathe, Kansas 66062, U.S.A.

GARMIN (Europe) Ltd.
Unit 5, The Quadrangle, Abbey Park Industrial Estate, Romsey, SO51 9AQ, U.K.

GARMIN Corporation
No. 68, Jangshu 2nd Road, Shijr, Taipei County, Taiwan

www.garmin.com

Part Number 190-00217-00 Rev. C